



**INSTRUCTIONS FOR USE &
MANUAL DAILY MAINTENANCE**

**CORNER BELL YORK 3 L/R
CF / LF / PF**

Gas fire with closed combustion system



Bellfires wishes you many cosy evenings with your new Bellfires gas fire

This document is an essential part of your gas fire.
Read it carefully before use of the gas fire and keep it in a safe place!



Serial number:
Production date:

BELLFIRES GAS FIRE WITH CLOSED COMBUSTION SYSTEM:

Corner Bell York 3 L/R CF (Centre Fire) (CBYK3 L/R CF)

Corner Bell York 3 L/R LF (Line Fire) (CBYK3 L/R LF)

Corner Bell York 3 L/R PF (Premium Fire) (CBYK3 L/R PF)

CONTENTS

	Page
1. WARRANTY TERMS	7
2. INSTRUCTIONS FOR USE	9
3. USING THE APPLIANCE FOR THE FIRST TIME	33
4. DAILY MAINTENANCE	34
5. ANNUAL MAINTENANCE	36

1 WARRANTY TERMS

Interfocos Warranty terms

Interfocos B.V. guarantees the quality of the supplied Bellfires hearth and the quality of the materials used. All Bellfires hearths are developed and manufactured according to the highest possible quality standards. If, despite all this, something should prove amiss with the Bellfires hearth you have purchased, Interfocos B.V. offers the following manufacturer's warranty.

Article 1: Warranty

- 1.1. If Interfocos B.V. determines that the Bellfires hearth you have purchased is defective as a result of a flaw in the construction or material, Interfocos B.V. guarantees to repair or replace the hearth free of charge, without charging any costs for labour or spare parts.
- 1.2. Repair or replacement of the Bellfires hearth will be undertaken by Interfocos B.V. or by a Bellfires dealer as designated by Interfocos B.V.
- 1.3. This warranty is supplementary to the existing legal national warranty of Bellfires dealers and Interfocos B.V. in the country of purchase and is not intended to restrict your rights and claims based on the applicable legal provisions.

Article 2: Warranty conditions

- 2.1. Should you wish to claim under the warranty, please contact your Bellfires dealer.
- 2.2. Complaints should be reported as quickly as possible after they have manifested themselves.
- 2.3. Complaints will only be accepted if they are reported to the Bellfires dealer, together with the serial number of the Bellfires hearth which is stated on the front of the instructions for use.
- 2.4. In addition, the original receipt (invoice, receipt, cash receipt) showing the date of purchase must also be submitted.
- 2.5. Repairs and replacements during the warranty period do not give any entitlement to an extension of the warranty period. After a repair or replacement of warranty parts, the warranty period shall be deemed to have started on the date of purchasing the Bellfires hearth.
- 2.6. If a certain part is eligible for the warranty and the original part is no longer available, Interfocos B.V. shall ensure that an alternative part of at least the same quality shall be provided.

Article 3: Warranty exclusions

- 3.1. The warranty on the Bellfires hearth ceases to be in effect if:
 - a. it is not installed according to the supplied installation instructions, and to national and/or local regulations;
 - b. it has been installed, connected or repaired by a non-Bellfires dealer;

- c. it has not be used or maintained according to the instructions for use;
 - d. it has been changed, neglected or roughly treated;
 - e. it has been damaged as a result of external causes (outside the hearth itself), for example, lightning strike, water damage or fire;
- 3.2. In addition, the warranty lapses if the original purchase receipt shows any change, deletion, removal or if it is illegible.

Article 4: Warranty area

- 4.1. The warranty is only valid in those countries where Bellfires hearths are sold through an official dealer network.

Article 5: Warranty period

- 5.1. This warranty will only be granted during the warranty period.
- 5.2. The body of the Bellfires hearth is guaranteed for a period of 10 years against construction and/or material faults, starting from the moment of purchase.
- 5.3. For other parts of the Bellfires hearth, a similar warranty applies from the moment of purchase for a period of one year.
- 5.4. For user parts such as glass, glass (cord), thermocouple and the interior of the combustion chamber, a similar guarantee is given until after the first burning.

Article 6: Liability

- 6.1. A claim granted by Interfocos B.V. under this warranty does not automatically imply that Interfocos B.V. also accepts liability for any possible damage. The liability of Interfocos B.V. never extends further than that stated in these warranty conditions. Any liability of Interfocos B.V. for consequential damage is expressly excluded.
- 6.2. That stated in this provision is not valid if and to the extent that is derives from a mandatory provision.
- 6.3. All agreements entered into by Interfocos B.V. are, unless specifically stated otherwise in writing and to the extent that they are permitted based on applicable law, subject to the Conditions of the Dutch Metal and Engineering Association (METAALUNIEVOORWAARDEN), as filed with the registrar of the Court of Rotterdam on 1 January 2014.

Interfocos B.V.
Hallenstraat 17
5531 AB Bladel
The Netherlands
Tel: +31-497339200
Email: info@Bellfires.com

Carefully retain the instructions for use; they show the serial number of the hearth. You will need this if you wish to claim under the warranty.

2 INSTRUCTIONS FOR USE

2.1 INTRODUCTION

Congratulations on your purchase of this modern Bellfires gas fire. This quality product will provide you with many years of enjoyment due to the flame effect and warmth that it provides.

Please read the instructions for use carefully before using the appliance for the first time. Keep this booklet in a safe place.

2.2 BUILT-IN PROTECTION OF THE APPLIANCE

The appliance is fully protected by means of a thermo-electric pilot light shut off in the event of a gas escape from the main burner.

In addition, the appliance is equipped with a safety system, whereby hatches will extract any over-pressure that arises in a controlled way. In this, the hatches in the ceiling of the combustion chamber, briefly open.

A loud noise can occur. If this happens, immediately close the gas tap and contact the fitter.

2.2.1 Safety



Do not place embers, vermiculite granules, wood logs or pebbles / 'fire glass' against the pilot light burner. Make sure that the pilot flame can burn at all times freely over the main burner. Only in this way is proper ignition of the main burner ensured.

Ignoring these directions could lead to a dangerous situation.



Do not place flammable objects within 100 cm of the appliance. Pay special attention to furnishings and ornaments around the fire.



When igniting the pilot light and burner, always keep a minimum distance of 100 cm from the front of the appliance.



If the pilot flame goes out for any reason, wait for 5 minutes before attempting to re-light it.



It is essential that the appliance, the complete concentric flue system and the outlet are cleaned and inspected annually by a recognised fitter/gas specialist. The safe operation of the appliance will thus remain guaranteed. For this, please refer to the Installation instructions (Chapter 2: Maintenance), that are supplied separately with each appliance.



The gas fire must never be used with the door open or the door glass removed.



Never place flammable material on the ceramic log set.



The filling of the main burner with embers, vermiculite granules, wood logs or pebbles / 'fire glass' may not under any circumstances be changed or added to.



Do not place easily-flammable materials, such as nylon clothing or flammable liquids, in the vicinity of the gas fire.



Ensure at all times that children and other people who are not aware of the operation of the gas appliance are only in the vicinity of the appliance exclusively under supervision.



Use a fireguard to protect the people and children mentioned above against possible burns.

2.3 FLAME EFFECT

The appliance is supplied with a "Centre Fire", "Line Fire" or "Premium Fire" double burner, as ordered, from the factory. These burners each have their own specific flame effect, see below for an impression.

Corner Bell York 3 L/R CF

The appliance is supplied with a "Centre Fire" double burner:



Both burners ON

Only front burner ON



Corner Bell York 3 L/R LF

The appliance is supplied with a “Line Fire” double burner:

Both burners ON

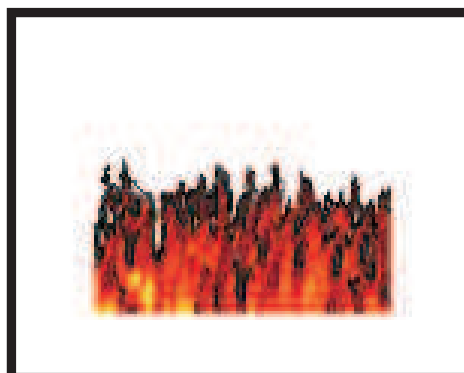

Only front burner ON



Corner Bell York 3 L/R PF

The appliance is supplied with a "Premium Fire" double burner:

Both burners ON



Only front burner ON



Natural gas: The above sketches provide an impression of the flame effect. This can differ from reality. The flame effect is namely dependant on the composition and supply pressure of the natural gas present.



Butane and Propane:

The flame effect produced by butane and propane is less realistic than with natural gas. The flame effect is less as far as flame volume and height are concerned!



2.4 OPERATION: REMOTE CONTROL



Remote control “Centre Fire” (CF)
“Line Fire” (LF)



Remote control “Premium
Fire” (PF)

2.4.1 General

Read these instructions carefully before lighting the fire !!

The appliance is operated by radio remote control. This comprises a hand-held transmitter and a receiver. The receiver is part of the gas control block assembly.

The receiver and the gas control block are behind the (white) panel door (operating unit) next to the appliance. Press the door inwards to open; this will release the catch and the door will spring out.

Electrical connections and batteries:

The appliance is supplied with a “Centre Fire” (CF) or “Line Fire” (LF) double burner:

Hand-held transmitter	2x 1.5V battery Type LR03 or AAA	
Receiver	4x 1.5V battery Type LR06 or AA	Option: 6VDC adapter (230 VAC). Available from your fitter. Note: Remove batteries from receiver!

The appliance is supplied with a “Premium Fire” (PF) double burner:

Hand-held transmitter	2x 1.5V battery Type LR03 or AAA	
Receiver	6VDC via the 5 wire cable from the Light-Module	Note: No batteries in the receiver. *)
Light-Module	230 VAC	

*) During a power outage, you can temporarily install batteries in the receiver so that the appliance continues to operate.

Note: Hand-held transmitter and receiver are **not** interchangeable with previous models.

The pilot light is situated in the front of the burner, behind a cowl. *Should the pilot light go out, you must wait five (5) minutes before attempting to re-ignite the fire.*

Important

Once the fire is lit, it must burn at maximum for approx. 10 minutes to allow the chimney to come up to temperature!

2.4.2 Hand-held transmitter

The remote control works by radio signal. The hand-held transmitter is configured in the factory with a unique signal code.

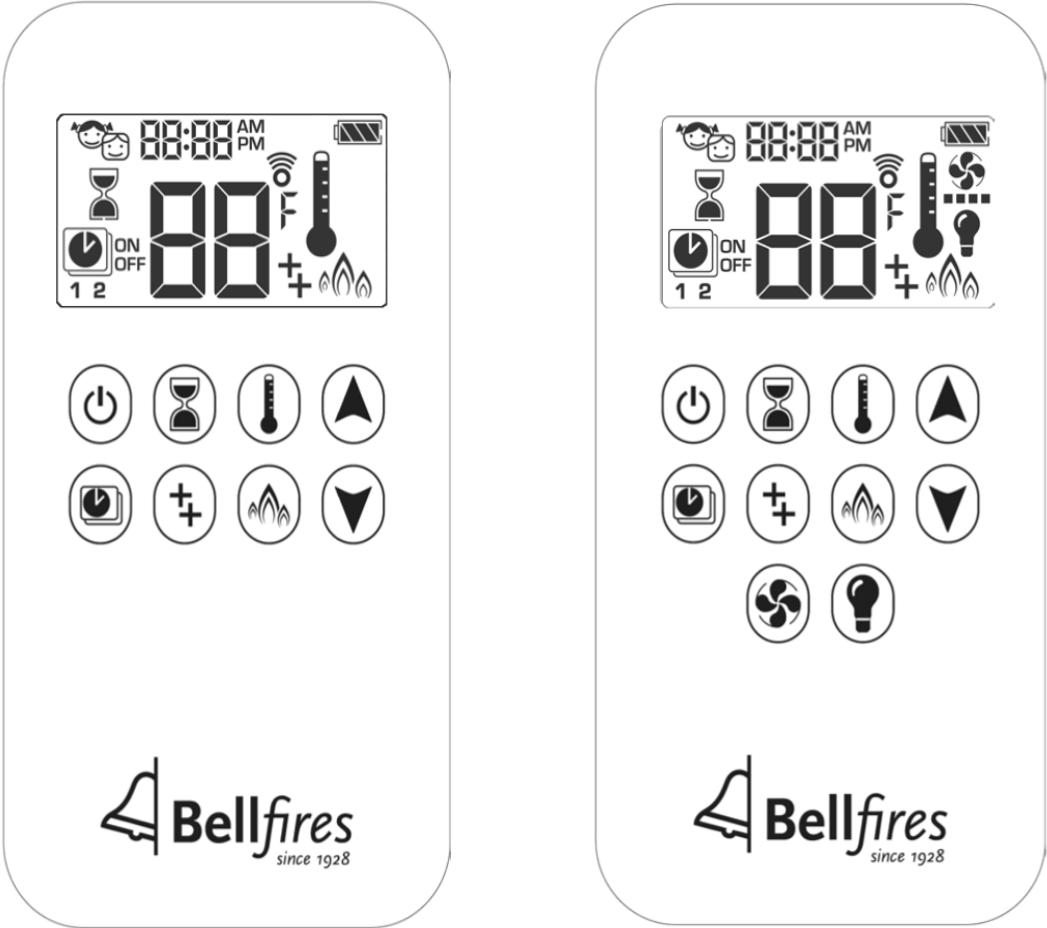
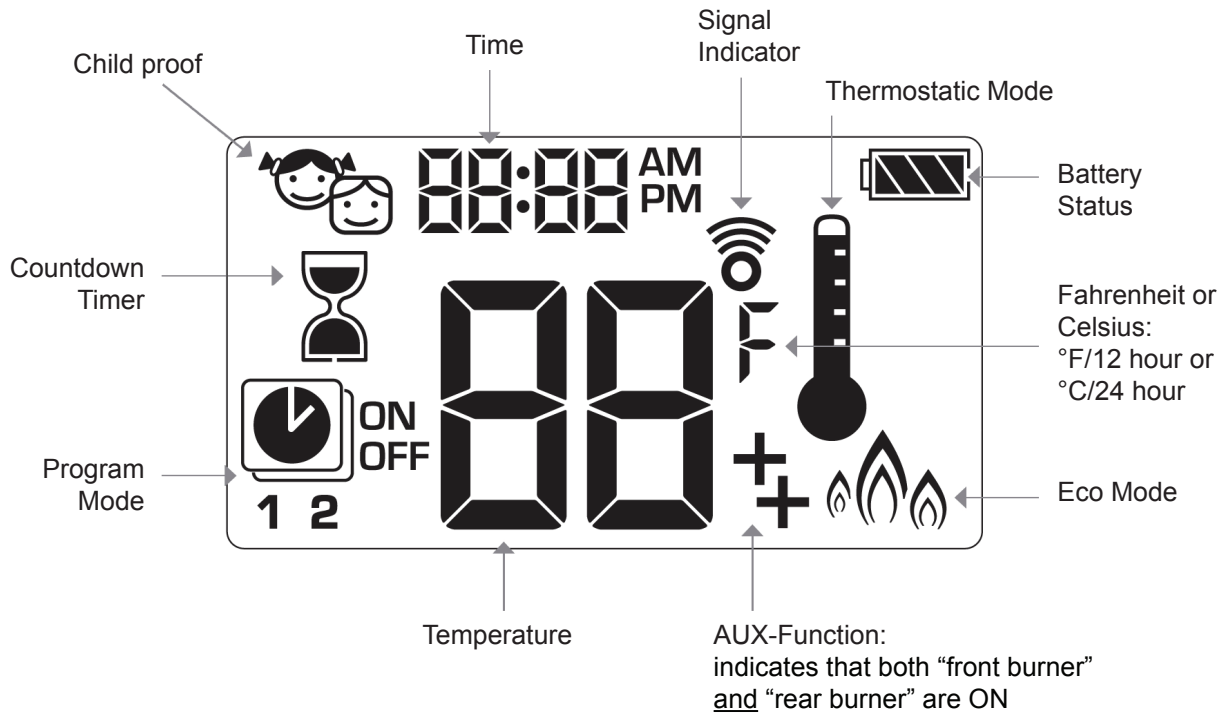
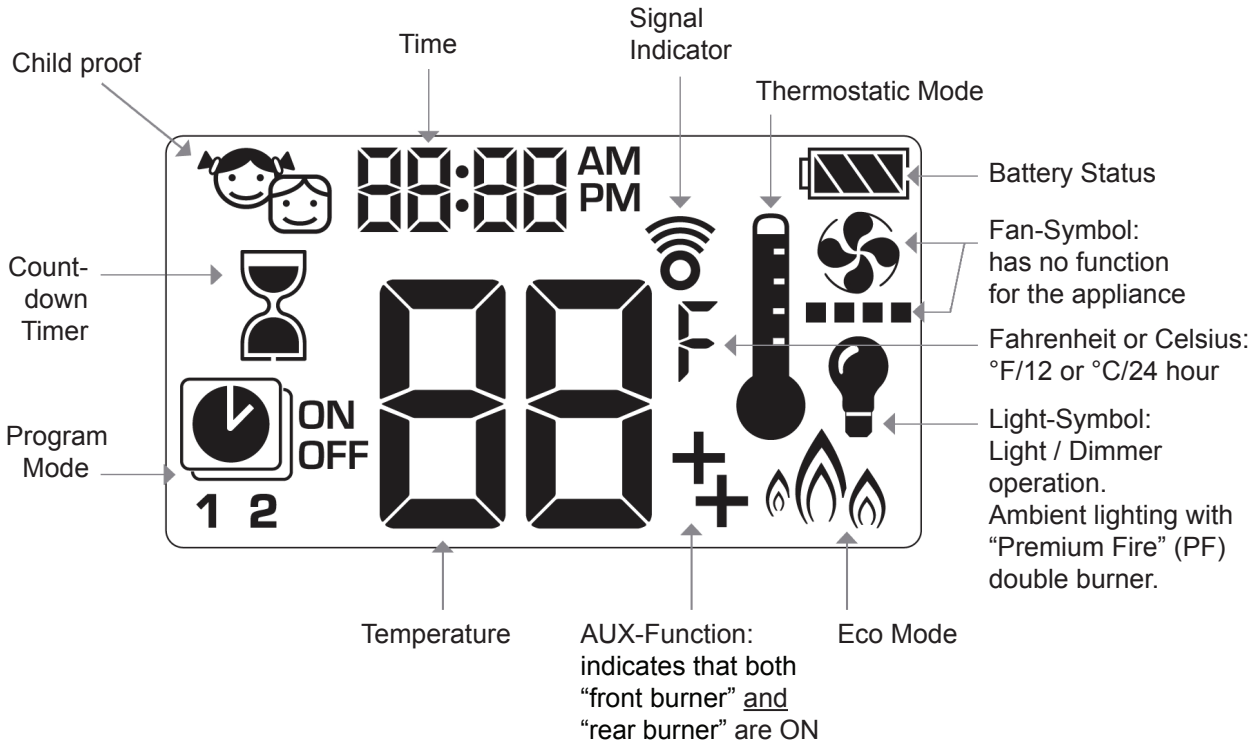

Figure 1: Hand-held transmitter CF/LF

Hand-held transmitter PF



Display hand-held transmitter CF/LF (8-Symbol display)



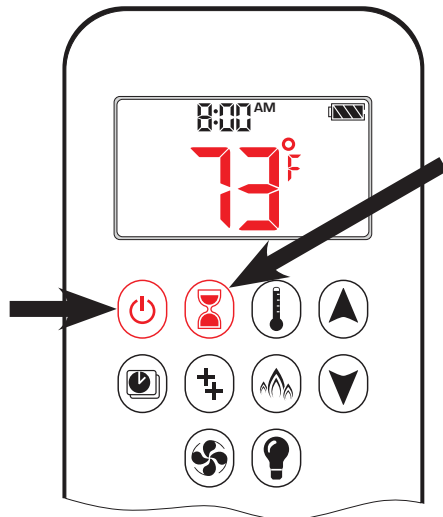

Display hand-held transmitter PF (10-Symbol display)

Figure 2: Display hand-held transmitter



SETTING FAHRENHEIT OR CELSIUS







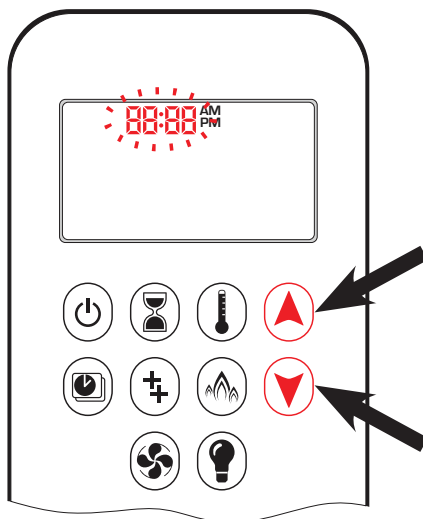







- To change between °C and °F, press  and  buttons simultaneously.

Note:

Choosing °F results in a 12 hour clock.
Choosing °C results in a 24 hour clock.



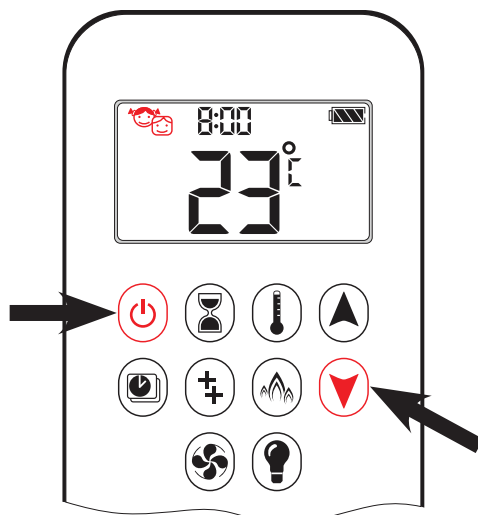

SETTING THE TIME

- Press  and  buttons simultaneously.
Day flashes.
- Press  or  button to select a number to correspond with the day of the week (e.g. **1**= Monday, **2**= Tuesday, **3**= Wednesday, **4**= Thursday, **5**= Friday, **6**= Saturday, **7**= Sunday).
- Press  and  buttons simultaneously.
Hour flashes.
- To select hour press  or  button.
- Press  and  buttons simultaneously.
Minutes flash.
- To select minutes press  and  button.
- To confirm press  and  buttons simultaneously or wait.





CHILD PROOF

ON:

- To activate press  and  buttons simultaneously.
-  displayed and the hand-held transmitter is rendered inoperable, except for the off function.

OFF:

- To deactivate press  and  buttons simultaneously.
-  disappears.

IMPORTANT: SETTING UP SIGNAL CODE BEFORE USING THE APPLIANCE FOR THE FIRST TIME

Before the appliance can be used, the receiver must first learn the hand-held transmitter's signal code.

- Press the **“RESET”** button on the receiver, and keep this pressed until 2 beeps are heard. See figure 3.
Release the **“RESET”** button after the second (somewhat longer) beep.
- Press, within 20 seconds, the  button (small flame) on the hand-held transmitter, until 2 short beeps are heard. The signal code has now been set up on the receiver.
If, however, a single long beep is heard, this means that setting the signal code has failed or that the wiring has been connected incorrectly.

You only need to set up the signal code once. It is not necessary when changing the batteries of the hand-held transmitter or receiver.

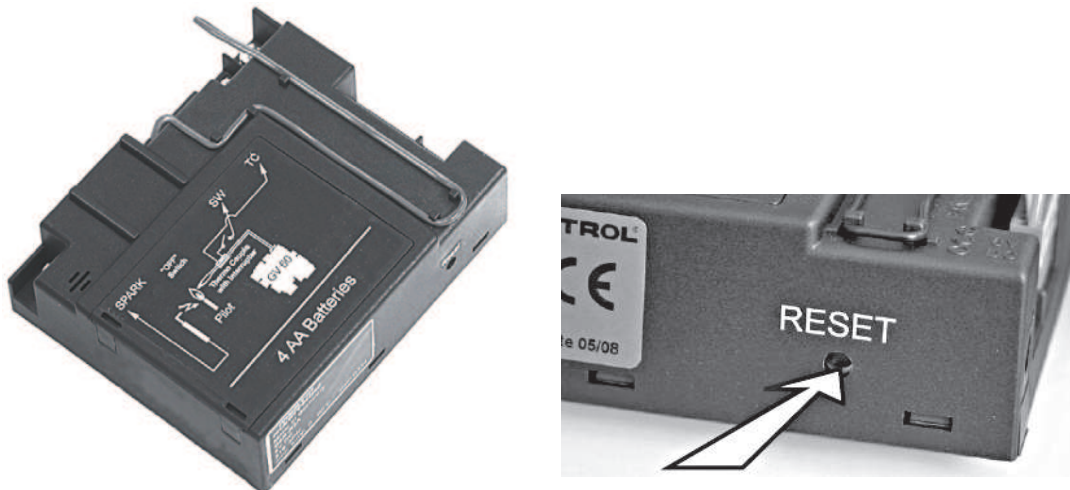



Figure 3: Receiver “RESET” button

Burner:

The appliance's entire burner consists of a “front burner” and a “rear burner”.
Burner operation described below applies to:

- 1 Both “front burner” and “rear burner”.
(The -symbol (AUX -function) on the hand-held transmitter's display is visible.)

or

- 2 Only “front burner”. The “rear burner” is turned off.
(The -symbol (AUX -function) on the hand-held transmitter's display is not visible.)

2.4.3 Operation (Remote control)

MANUAL MODE (HAND-HELD TRANSMITTER)

SWITCH ON THE APPLIANCE / IGNITING THE FIRE

- Open the gas supply valve in the gas pipe to the fire.



Warning

When the pilot light is ignited, the motor turns automatically to maximum flame height.

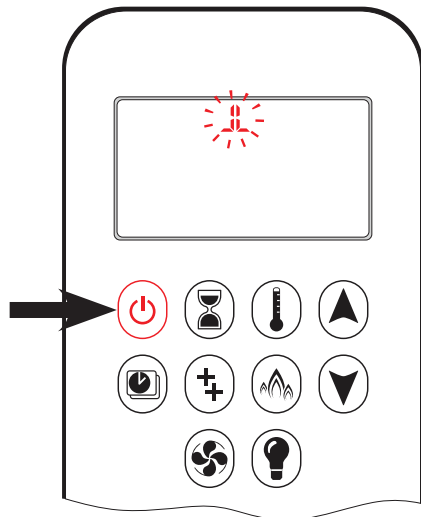

Hand-Held Transmitter One-Button Operation (Default Setting)

- Press  button until two short beeps and a blinking series of lines confirms the start sequence has begun; release button.
- Main gas flows once pilot ignition is confirmed.
- Hand-held transmitter automatically goes into Manual Mode after main burner ignition.



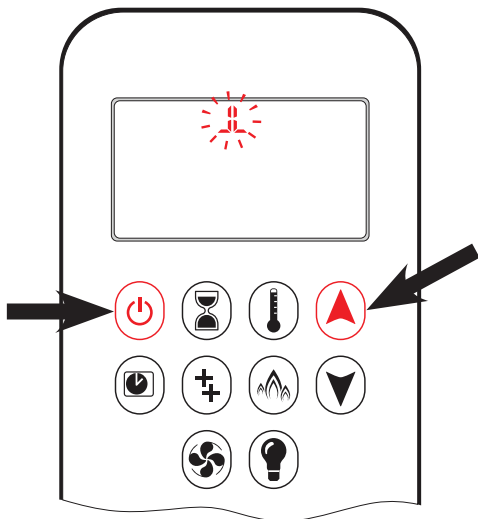

Note

Change from one-button to two-button ignition operation by pressing and holding  button for 10 sec. immediately after installing batteries. **ON** is displayed and **1** is flashing. When change is complete **1** will change to **2**.



Hand-Held Transmitter Two-Button Operation

- Press  and  button simultaneously until two short beeps and a blinking series of lines confirms the start sequence has begun; release buttons.
- Main gas flows once pilot ignition is confirmed.
- Hand-held transmitter automatically goes into Manual Mode after main burner ignition.



Note

Change from two-button to one-button ignition operation by pressing and holding  button for 10 sec. immediately after installing batteries. **ON** is displayed and **2** is flashing. When change is complete **2** will change to **1**.

Important:



- If the pilot flame goes out for any reason, wait for **5 minutes** before attempting to re-light it.
- If the pilot light does not ignite after 3 ignition attempts; close the gas tap and warn the fitter.
- Once the pilot light is burning, the main burner must ignite **within 10 seconds** automatically. If this does not happen, **immediately** close the gas tap and warn the fitter.
- If the main burner ignites with a pop; **immediately** close the gas tap and warn the fitter.

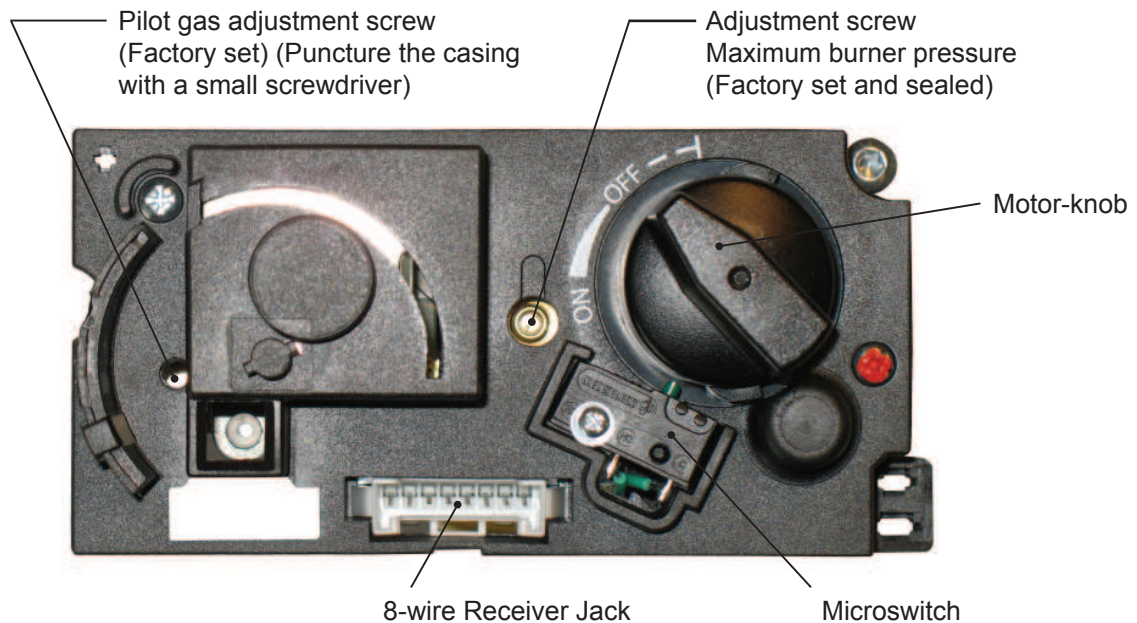

Figure 4: Gas regulating block

- Possible error messages:
 - * 3 seconds: short beeps, audible when the motor-knob operates:
Receiver batteries need changing soon (having heard this signal, the appliance can be ignited another ten times approximately).
 - * 5 seconds: unbroken beeps:
Error. For example, one of the cables may not be properly connected.

Important: If the pilot flame goes out, then wait for at least **5 minutes** before repeating the above procedure.



STAND-BY MODE (PILOT LIGHT)



- Press  button and hold to set appliance to pilot light.

We recommend to let the pilot light burn in the winter months, to prevent condensation on the inside of the glass.

SETTING THE FLAME HEIGHT / EXTINGUISHING THE FIRE (STAND-BY)



Gradually decrease flame height / Extinguishing the fire

- After ignition, the burner automatically sets the flames to the maximum height.
- Press ▼ button to lower the flames and to turn off the burner. (Extinguishing the fire: Press ▼ button and hold: pilot light remains burning (standby position)!) (Pressing briefly the ▼ button gradually lowers the flames to the low position.)

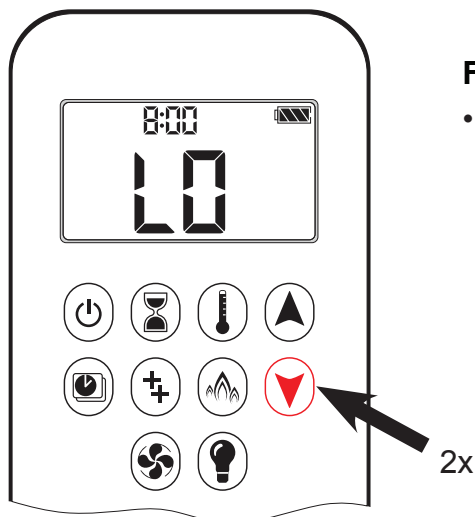

Flame height directly to minimum position

- Pressing the ▼ button twice, automatically lowers the flames to the low position. (When this happens, the flames will first automatically go to maximum!) This is indicated by “LO” on the display.

Note: Backlight must be on for high fire and low fire double-click operation!

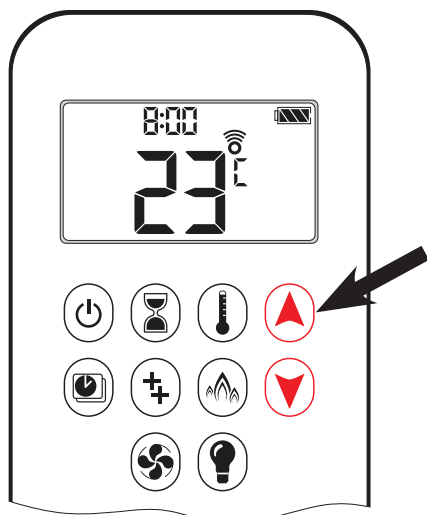

Gradually increase flame height

- Press ▲ button and hold to increase the flame level and to turn on the burner from the stand-by position. (Pressing briefly the ▲ button gradually increases the flames to the high position.)

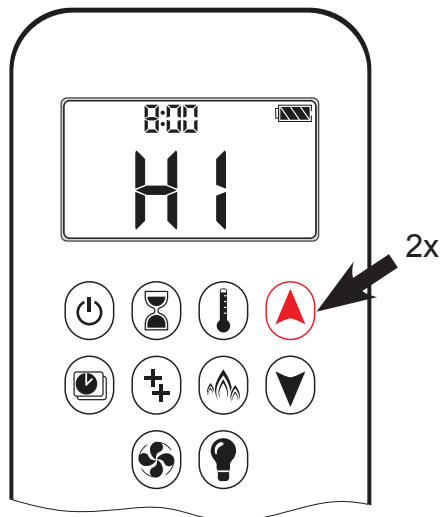

Flame height directly to maximum position

- Pressing the  button twice automatically increases the flames to the high position. This is indicated by “HI” on the display.

Note: Backlight must be on for high fire and low fire double-click operation!

Important:





- If you turn on the burner by pressing the  button, it must ignite within 10 seconds. If this does not happen, immediately close the gas tap and warn the fitter.
- If the burner ignites with a pop; immediately close the gas tap and warn the fitter.

TURNING THE “REAR BURNER” ON AND OFF

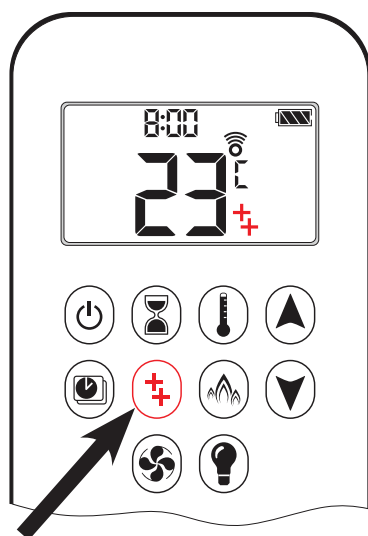
After igniting the pilot light and the burner, the “front burner” is turned on (ON) and the “rear burner” remains in the last chosen setting.



Turning on the “rear burner”

- Press  button to turn the “rear burner” ON. The  -symbol (AUX -function) appears on the hand-held transmitter’s display.

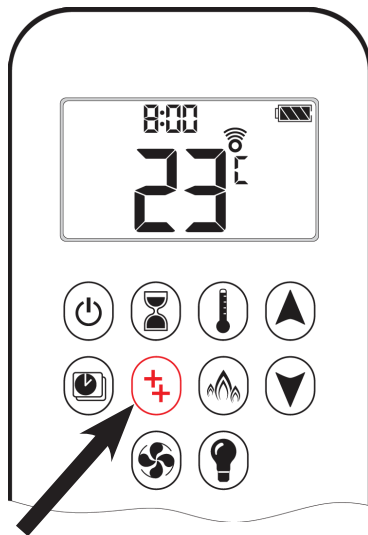

Turning off the “rear burner”

- Press button to turn the “rear burner” OFF. The -symbol (AUX -function) disappears on the hand-held transmitter’s display.

Notes:

- 1 The “rear burner” always remains in the last switching position chosen.
- 2 Also when the receiver’s batteries are depleted the “rear burner” remains in the last chosen setting.

LIGHT/DIMMER OPERATION

(Only for appliance with “Premium Fire” (PF) double burner)



ON

- Press button.
- displayed.
- Light is on at preset level.

OFF

- Press button.
- disappears.

SETTING

- Press button and hold until flashes.
- To adjust light between 20...100 % press or button.
- To confirm setting either press button or wait.
- displayed.

Note:

The Light works independently of the Pilot flame. If you want the light on but no flame, press button. If the main burner and pilot light are switched off, with button, the light will switch off automatically.

COUNTDOWN TIMER

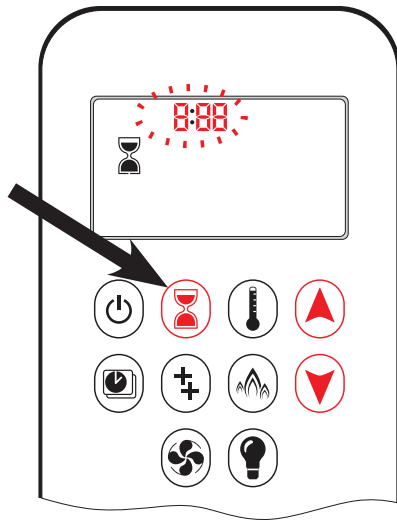

ON/SETTING

- Press button and hold until displayed, and **hour** flashes.
- To select hour press or button.
- To confirm press button. **Minutes** flash.
- To select minutes press or button.
- To confirm press button or wait.

OFF

- Press button, and countdown time disappear.

Note:

At end of countdown time period, the fire turns completely off. The Countdown Timer only works in Manual, Thermostatic, and Eco Modes. Maximum countdown time is 9 hours and 50 minutes.

TURNING OFF THE APPLIANCE COMPLETELY

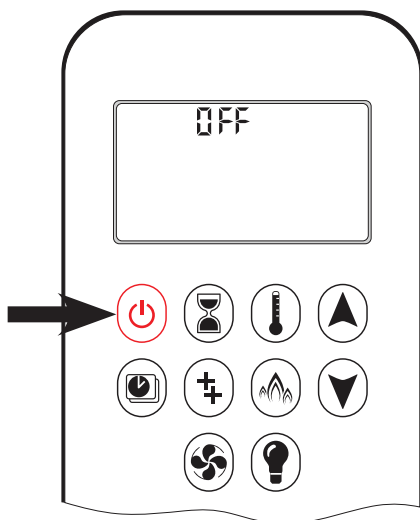

Hand-held transmitter

- Press button to turn off.
- If the appliance is not to be used for some time, please close the gas supply valve in the gas pipe.

Note:

There is a 5 seconds delay before the next ignition is possible.

Important:



If the pilot flame goes out for any reason, wait for **5 minutes** before attempting to re-light it.

MODES OF OPERATION



Thermostatic Mode

The room temperature is measured and compared to the set temperature. The flame height is then automatically adjusted to achieve the set temperature.

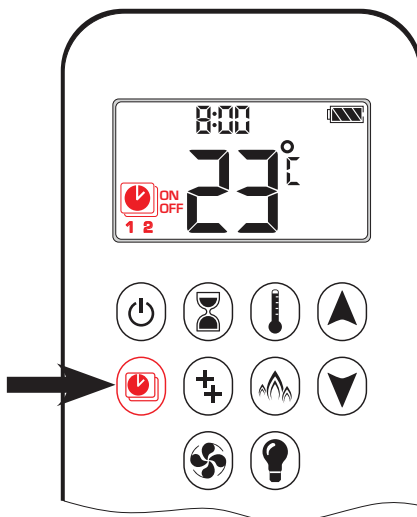

Program Mode

PROGRAMS 1 and 2, each can be programmed to go on and off at specific times at a set temperature.

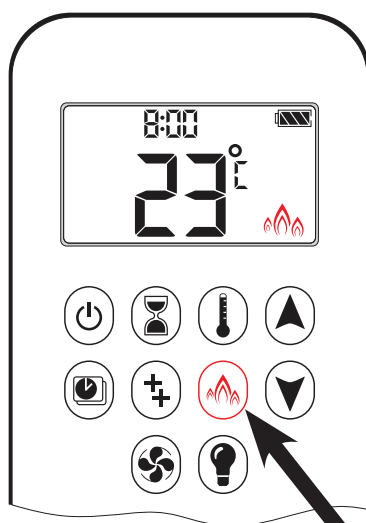

Eco Mode

Flame height modulates between high and low. If the room temperature is lower than the set temperature, the flame height stays on high for a longer period of time. If the room temperature is higher than the set temperature, the flame height stays on low for a longer period of time. One cycle lasts approx. 20 min.

THERMOSTATIC MODE

**ON**

1. Press button.
2. displayed, preset temperature displayed briefly, and then room temperature displayed.

OFF

1. Press button.
2. Press or button to enter Manual Mode.
3. Press button to enter Program Mode.
4. Press button to enter Eco Mode.

**SETTING**

1. Press button and hold until displayed, temperature flashes.
2. To adjust set temperature press or button.
3. To confirm press button or wait.

Important:

Place the hand-held transmitter in a place that is not influenced by direct sunlight, draught, heat from the appliance and other heat sources.

PROGRAM MODE

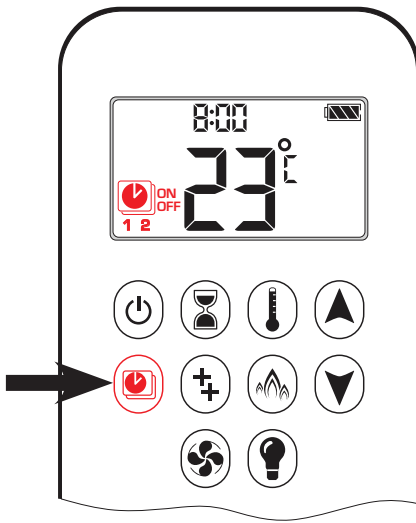

ON

1. Press button.
2. , 1 or 2, **ON** or **OFF** displayed.

OFF

1. Press or or button to enter Manual Mode.
2. Press button to enter Thermostatic Mode.
3. Press button to enter Eco Mode.

Note:

The set temperature for Thermostatic Mode is the temperature for the on time in Program Mode. Changing the Thermostatic Mode set temperature also changes the on time temperature in Program Mode.

Default settings

ON TIME (Thermostatic) TEMPERATURE: 21 °C (70 °F)

OFF TIME TEMPERATURE: “--” (pilot light only)

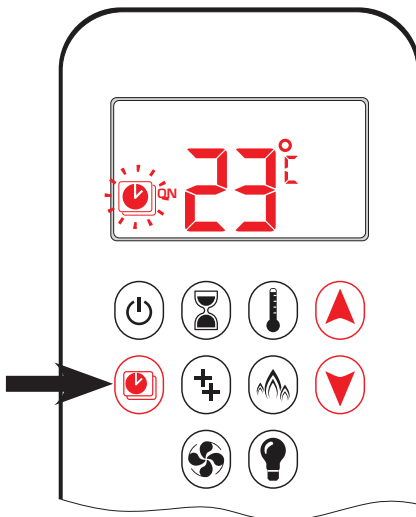

TEMPERATURE SETTING

1. Press button and hold until flashes.
ON and set temperature (setting in Thermostatic Mode) displayed.
2. To continue press button or wait.
, **OFF** displayed, temperature flashes.
3. Select off temperature by pressing the or button.
4. To confirm press button.

Note:

The on (Thermostatic) and off set temperatures are the same for each day.

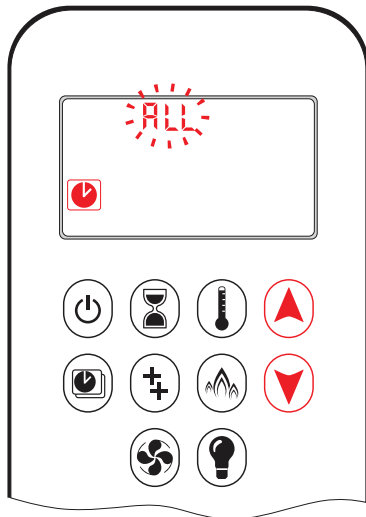

DAY SETTING

5. ALL flashes. Press ▲ or ▼ button to choose between ALL, SLEEP, 1, 2, 3, 4, 5, 6, 7.
6. To confirm press ⏻ button.

ALL selected

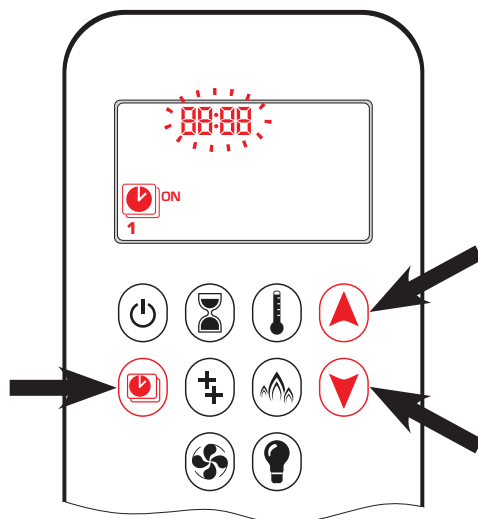

ON TIME SETTING

(PROGRAM 1)

7. ⏻, 1, ON displayed, ALL is displayed shortly, and hour flashes.
8. To select hour press ▲ or ▼ button.
9. To confirm press ⏻ button.
⏻, 1, ON displayed, ALL displayed shortly, and minutes flash.
10. To select minutes press ▲ or ▼ button.
11. To confirm press ⏻ button.

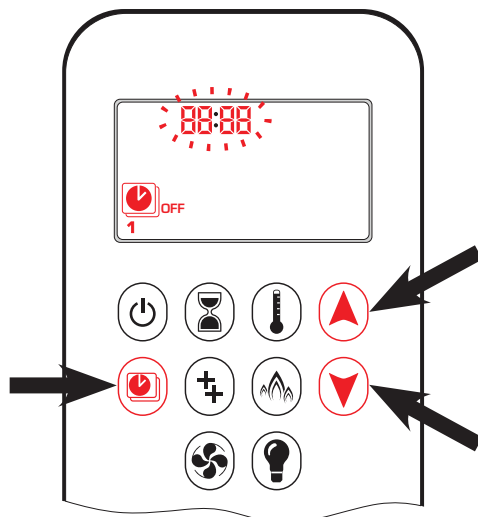

OFF TIME SETTING

(PROGRAM 1)

12. ⏻, 1, OFF displayed, ALL is displayed shortly, and hour flashes.
13. To select hour, press ▲ or ▼ button.
14. To confirm press ⏻ button.
⏻, 1, OFF displayed, ALL displayed shortly, and minutes flash.
15. To select minutes press ▲ or ▼ button.
16. To confirm press ⏻ button.

Note:

Either continue to PROGRAM 2 and set on and off times or stop programming at this point, and PROGRAM 2 remains deactivated.

Note:

PROGRAM 1 and 2 use the same on (Thermostatic) and off temperatures for ALL, SAT-SUN and Daily Timer (1, 2, 3, 4, 5, 6, 7).

Once a new on (Thermostatic) and/or off temperature has been set, that temperature becomes the new default setting.

Note:

If ALL, SAT-SUN or Daily Timer are programmed for PROGRAM 1 and PROGRAM 2 on and off times, these become the new default times. The batteries must be removed to clear the PROGRAM 1 and PROGRAM 2 on and off times and temperatures.

SAT-SUN or Daily Timer (1, 2, 3, 4, 5, 6, 7) selected

- Set on time and off time using same procedure as “ALL selected” (above).
- SAT-SUN: Set on time and off time for both Saturday and Sunday.
- Daily Timer: Unique on and off times may be set for a single day of the week, for multiple days of the week, or for every day of the week.
- Wait to finish setting.

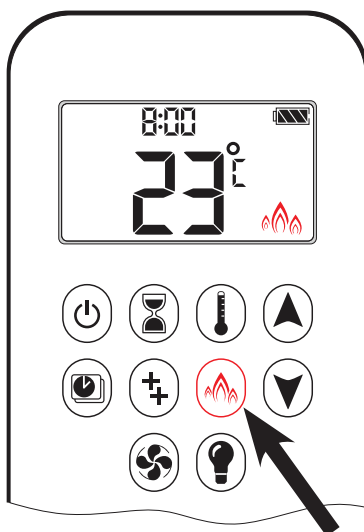
ECO MODE**ON**

- Press  button to enter Eco Mode.
- The symbol  appears.

OFF

- Press  button.
- The symbol  disappears.

Faults

- If the signals from the hand-held transmitter do not seem to be reaching the receiver, the cause may be:
 - * Spent batteries: replace the batteries.
 - * An electronic problem: press the “**RESET**” button on the receiver.
- If the appliance regularly switches itself off, please contact your installer.

Replacing the batteries

- If the batteries are inserted incorrectly, the electronics or drive may be irreparably damaged.
- Only replace the batteries when the appliance has been completely switched off.

The appliance is supplied with a “Centre Fire” (CF) or “Line Fire” (LF) double burner:

- The hand-held transmitter/receiver batteries have a service life of approx. one year. We recommend you use alkaline batteries. Rechargeable batteries are not permitted.

- If the receiver’s batteries are nearly empty, the system will turn the appliance off completely. This will not occur if the receiver is connected to an AC power adaptor (6V) (option).

- The batteries must be replaced whenever:

1 Hand-held transmitter : The battery symbol indicates this in the display.



: Battery fully charged



: Battery empty

2 Receiver: 3 seconds: short beeps, audible when the motor-knob operates.

1 Hand-held transmitter:

- * Open the cover on the back of the transmitter.
- * Remove the batteries from the battery compartment.
- * Place two new 1.5V batteries (LR03 or AAA type) as indicated in the battery compartment.
- * Close the cover.

2 Receiver:

- * Carefully pull the receiver assembly out of the compartment.
- * Open the cover.
- * Remove the batteries from the battery compartment.
- * Place four new 1.5V batteries (LR06 or AA type) as indicated in the battery compartment. The negative end (-) of the battery must always be at the contact spring end of the compartment.
- * Close the cover and place the receiver back in its holder.

The appliance is supplied with a “Premium Fire” (PF) double burner:

- Receiver:
Because the appliance is equipped with a 230 VAC connection, no batteries are present in the receiver.
- Hand-held transmitter:
The hand-held transmitter batteries have a service life of approx. one year. We recommend you use alkaline batteries. Rechargeable batteries are not permitted. Replacement of the batteries is necessary when the battery symbol indicates this in the display.



: Battery fully charged



: Battery empty

- * Open the cover on the back of the transmitter.
- * Remove the batteries from the battery compartment.
- * Place two new 1.5V batteries (LR03 or AAA type) as indicated in the battery compartment.
- * Close the cover.

3 USING THE APPLIANCE FOR THE FIRST TIME

The gas fire is coated with a lacquer layer resistant to high temperature.

During the first hours of operation, the burning in of the lacquer may result in an unpleasant smell. This is harmless, however.

Operating the gas fire at full capacity for a few hours, while ventilating the room, will eliminate the smell.

After using your gas fire for the first few times, you may be aware of a light deposit on the inside of the glass. This is caused by the paint curing.

Once your fireplace has cooled down, this deposit can be removed with glass cleaner or ceramic hob cleaner.

4 DAILY MAINTENANCE

- Ensure that as little dust, and as few particles of cigarette smoke, candles and oil lamps as possible pollute the air in the room in which the appliance is used. Heating of these particles by the convection system of the appliance could lead to discoloration of the walls and ceiling. It is therefore very important to ensure that the room in which the appliance is located is sufficiently ventilated. Regularly remove any dust deposits from behind the (white) panel door (operating unit) by means of a vacuum cleaner.

- **If the glass is broken or cracked, it must be immediately replaced before operating the gas fire again.**



Broken ceramic heat-resistant glass may not be disposed in a glass recycling container, but must be included in normal household waste.

- If anything is spilt on the fire, switch it off immediately and wait for it to cool down sufficiently before cleaning. Never use scouring powder, aggressive cleaners or fire polish on the gas fire. Use only a dry lint free cloth.
- Heat resistant lacquer in aerosols can be obtained from your distributor. During the yearly maintenance, the lacquer can be used to repair small areas of damage.

4.1 MAINTENANCE SPECIFICATIONS FOR ANTI-REFLECTIVE GLASS

When the appliance is equipped with a pane of **anti-reflective** ceramic glass, one needs for the cleaning the pane, to observe the following maintenance instructions.

- **To prevent damage to the coating layers on the glass, the use of hard (scouring) sponges, steel wool, abrasives and cleaning agents containing ammonia is forbidden. The use of caustic products and products containing abrasives, such as ceramic hob cleaners, is also forbidden.**
- If the glass needs to be cleaned on the inside, it should be removed from the appliance. Instructions for removing the glass can be found in Chapter 4.1 of the "Installation Instructions & Maintenance Manual" booklet.
- Make exclusive use of a neutral cleaning agent (neither acidic nor alkaline), for instance "Instanet" or Glassex". This means that the cleaning agents which we usually advise for 'standard' glass, may not be used for anti-reflective glass.
- Use a soft cloth / sponge (no paper).
- A white haze can form on the glass during the appliance's first few burning hours. Remove this haze immediately.

- Clean the inside and the outside of the glass regularly. The frequency of cleaning depends on the degree of contamination. Not cleaning the glass in time can cause it to become dull and difficult, if not impossible, to clean.
- Always rub the pane completely dry: Water droplets (residual water) can leave marks on the coating.
- Fingerprints are more visible on anti-reflective glass: Wear (rubber) gloves when gripping the pane.
- If the pane is lifted using a vacuum lifter, the rubber of the suction pad must be clean and dry in order to avoid damaging the coating.

4.2 MAINTENANCE SPECIFICATIONS FOR 'STANDARD' GLASS

When the appliance is equipped with a pane of “**standard**” ceramic glass, one needs for the cleaning the pane, to observe the following maintenance instructions.

- Regularly clean the glass on the inside of the appliance with glass cleaner or ceramic hob cleaner.
- If the glass needs to be cleaned on the inside, it should be removed from the appliance. Instructions for removing the glass can be found in Chapter 4.1 of the “Installation Instructions & Maintenance Manual” booklet.
- Use a soft cloth / sponge / paper.
- A white haze can form on the glass during the appliance’s first few burning hours. Remove this haze immediately.
- Clean the inside and the outside of the glass regularly. The frequency of cleaning depends on the degree of contamination. Not cleaning the glass in time can cause it to become dull and difficult, if not impossible, to clean.
- Always rub the pane completely dry: Water droplets (residual water) can leave marks on the glass.
- Fingerprints are visible on the glass: Wear gloves when gripping the pane.
- If the pane is lifted using a vacuum lifter, the rubber of the suction pad must be clean and dry in order to avoid marks on the pane.

5 ANNUAL MAINTENANCE



It is **essential** that the appliance, the complete concentric flue system (where possible) and the outlet are cleaned and inspected **annually** by a recognised fitter/gas specialist. The safe operation of the appliance will thus remain guaranteed.

Please refer also to the Installation instructions that are supplied separately with each appliance.



Your Bellfires dealer

01 - 300117 - 344204