



**INSTALLATION INSTRUCTIONS &
MANUAL FOR MAINTENANCE**

**YORK LARGE 3
CF/LF**

Gas fire with closed combustion system

Bellfires wishes you many cosy evenings with your new Bellfires gas fire

This document is an essential part of your gas fire. Read it carefully before installation and maintenance of the gas fire and keep it in a safe place!



Serial number:

Production date:

BELLFIRES GAS FIRE WITH CLOSED COMBUSTION SYSTEM:

York Large 3 CF (Centre Fire) (YKL3 CF)

York Large 3 LF (Line Fire) (YKL3 LF)

CONTENTS

| | Page |
|--|------|
| 1. INSTALLATION INSTRUCTIONS | 7 |
| 2. MAINTENANCE | 67 |
| 3. FAULTS | 68 |
| 4. DISMANTLING / ASSEMBLING OF THE GLASS | 69 |
| 5. DIAGRAM ELECTRICITY AND GAS | 75 |
| 6. DIMENSIONS | 76 |
| 7. TECHNICAL DETAILS/REGULATIONS | 84 |
| 8. REPLACEMENT PARTS LIST | 88 |
| 9. DISPOSAL OF PACKAGING AND APPLIANCE | 91 |

IMPORTANT



**The installation must only be carried out by a
“Gas Safe Register” registered installation engineer.**

1 INSTALLATION INSTRUCTIONS

1.1 GENERAL

The gas fire must be positioned and connected as a “room sealed system” (balance flue) appliance by a “Gas Safe Register” registered gas installation engineer in accordance with the following installation instructions, nationally and locally applicable regulations (see “Technical Details/ Regulations” at the rear of this manual). If you have any queries regarding the installation, please consult your local gas company.

Important:  **Before beginning the installation, check that the details on the rating plate correspond to the gas type and pressure to which the appliance will be connected.**

The appliance is supplied with a “Centre Fire” or “Line Fire” double burner, as ordered. These burners each have their own specific flame image which is defined by the perforation pattern in the burner cover. See Chapter 5 and the Instructions for use.

The appliance is factory set to the correct nominal heat input. The pilot light is set to the correct level of consumption.

Depending on the requested version, the appliance will be delivered from the factory with a Ø100 mm - Ø150 mm or Ø130 mm - Ø200 mm concentric connection for extracting the flue gases and supply of combustion air.

It is possible to install the gas fire with either a wall or roof outlet.

The roof connection must be carried out using the concentric flue system Ø100 mm - Ø150 mm. The fumes are exhausted naturally to the outside environment through the inner Ø100 mm pipe whereas the combustion air supply passes between the Ø100 mm and Ø150 mm pipes.

The wall connection must be carried out using the concentric flue system Ø130 mm - Ø200 mm. The flue gases are evacuated outside by means of natural draft through the internal pipe of Ø130 mm, whereas the combustion air is supplied between the pipes of Ø130 mm and Ø200 mm. The wall outlet itself is, depending on the concentric flue gas system configuration, Ø100 mm - Ø150 mm or Ø130 mm - Ø200 mm. (In some cases, with a wall connection, a complete concentric flue system Ø100 mm - Ø150 mm is also possible (see Chapter 1.6.1).)

The gas fire can be installed in a completely sealed or mechanically ventilated house without extra ventilation and/or fume extraction.

The gas fire is installed as a **built-in** appliance in a fireplace.

In order to prevent the fireplace heating up excessively, it must be properly ventilated by installing vents at the top and bottom of the fireplace.

The appliance can be fitted with a convection package as an optional extra. This is a convection top plate for on top of the appliance, two flexible aluminium pipes and two built-in convection vents. This enables hot air to be circulated into the room.

If required, two additional convector grills can be fitted (= 1x extra convection set).

If an existing chimney is to be used, please consult your installer first. If the chimney was previously used for a wood or coal fire, then it should be cleaned by an expert.

1.2 CONCENTRIC FLUE SYSTEMS Ø100 MM - Ø150 MM AND Ø130 MM - Ø200 MM :

- **Bellfires (Muelink & Grol system)**
- **Poujoulat (PGI system)**
- **Ontop (Metaloterm US system)**

The gas fire, in combination with the concentric flue system [Ø100 mm - Ø150 mm] and/or [Ø130 mm - Ø200 mm] (rigid and/or flexible) for the brands Bellfires (Muelink & Grol system), Poujoulat (PGI system) or Ontop (Metaloterm US system), has been approved in accordance with the European CE-norm for gas appliances and may therefore be used only with these systems. The permitted components for these systems are listed in Chapter 1.6.2. The guarantee on the appliance lapses if it is installed, fully or partially, with other components or a different flue system.

The concentric flue [Ø100 mm - Ø150 mm] and [Ø130 mm - Ø200 mm] systems can be used with either a newly-built or existing chimney.

1.3 INCLUDED

| | |
|-------------------|---|
| Set documentation | <ul style="list-style-type: none"> - Instructions for use - Installation instructions |
| Attributes | <ul style="list-style-type: none"> - Ceramic log set, or marble pebbles white or marble pebbles grey - Hook (for opening the frame and the glass) |

N.B. If any part is missing, please contact your dealer.

1.4 OPTIONS AND ACCESSORIES

The following options and accessories can be supplied by your dealer:

| <u>Part no</u> | <u>Option</u> |
|----------------------------|---|
| 331456 330714 312829 | <u>Convection package York Large 3</u> <ul style="list-style-type: none"> • 1x Convection casing • 1x Top plate Convection • 1x Convection set General |
| 331295 | Black mirror, rear wall YKL3 |
| 329707 | Black mirror sidewall DYL3/YKL3 |
| 332167 | Fins set YKL3 |
| 330361 | Set of high adjustable feet (4 pieces) |
| 311967 | Mantle iron, L = 1250 mm |

| <u>Part no</u> | <u>Accessorie</u> |
|--|---|
| 302092 | Adapter receiver 6 VDC |
| 312829 302188 310178 309872 309730 304040 | <u>Convection set General: (for convection air extraction)</u> <ul style="list-style-type: none"> • 1x Flexible aluminium pipe Ø125 mm, L= 3 m (max.) • 2x Fitting box 135 x 135 mm • 2x Convection exit grid, white, 145 x 145 mm • 2x Collar adaptor Ø125 mm • 4x Hose clamp Ø125 mm |
| 329874 | Set carrying brackets (2 pieces) |
| 3..... | Bellfires (M&G) concentric flue system See component summary |
| 3..... | Poujoulat (PGI) concentric flue system See component summary |
| 3..... | Ontop (Metaloterm US) concentric flue system See component summary |

1.5 PREPARATION FOR INSTALLATION

The following preparation must be carried out before the gas fire can be installed.

1.5.1 Instructions for positioning the outlet

1.5.1.1 Positioning the outlet for correct operation:

Roof-mounted outlet:

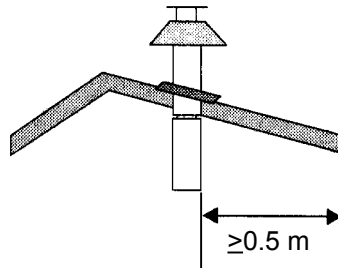

Figure 1: Roof-mounted outlet

This must be positioned at least 0.5 m from the roof edge; the apex of the roof can be disregarded.

Wall-mounted outlet:

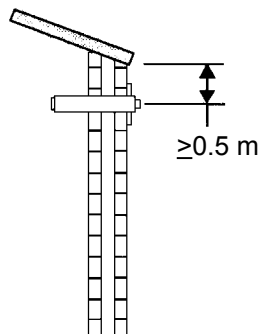

Figure 2: Wall-mounted outlet

This must be positioned at least 0.5 m from:

- the corner of the building.
- the roof overhang, the rain gutter.
- balconies etc., unless the exhaust construction extends to at least the face of the protruding section.

1.5.1.2. Positioning the outlet to avoid affecting the surrounding area



All listed “distances” in this section are no more than guidelines.

For the exact minimum “distances”, please consult your national and local directives.

“Distance” = minimum distance required for positioning of the outlet to avoid adverse effects with respect to:

- A. A ventilation opening serving an occupied room, a toilet or a bathroom.
- B. A heating air supply, when the supply flows through an occupied room.
- C. A window that can be opened and that is near an occupied room, a toilet or a bathroom.

Roof-mounted outlet:

| <u>To avoid adverse effects</u> | <u>Distance: outlet - A, B or C</u> |
|---------------------------------|-------------------------------------|
| At the same roof level. | >3 m (*) |
| At a different roof level. | >1 m (*) |
| At a lower positioned wall. | >1 m |
| At a higher sloping surface. | >3 m (**) |

(*) If the required distance cannot be achieved, the outlet position rules take precedence.

(**) If the required distance cannot be achieved, the position of the outlet must be at least 1 m above the highest facade/roof.

Wall-mounted outlet:

| <u>To avoid adverse effects</u> | <u>Distance: outlet - A, B or C</u> |
|---|---|
| At walls in buildings with staggered heights. | Not permitted if A, B, or C are located above the outlet. |
| On a wall - general. (*) | Above the outlet: >2 m Below the outlet: >0.75 m Left and right of the outlet: >0.75 m |
| At <1 m from the roof overhang. | >2 m |
| Beneath balconies, walkways etc. | >2 m from the underside of the protruding balcony or walkway. |
| Beneath balconies, walkways etc. where the outlet extends to the front. | >2 m |
| To the garden or on the terrace. | >2 m to the outside space. (**) |
| With respect to a facing wall. | >2 m (if the distance from the facing wall is less, the criteria detailed for "On a wall - general" apply). |
| Enquire at your local gas company for the regulations relating to outlets positioned opposite each other and outlet(s) in facade(s) that form an angle. | |

(*) These minimum distances do not apply if there is an obstruction between the outlet and A, B and C that protrudes at least 0.5 m from the wall and has a length exceeding the distance.

(**) This distance is not required if the outlet is situated at least 1 m higher than the intended area of the outside space.

If the outlet has a clearance of less than 0.5 m from the hard surface of a public area at a height of less than 2 m, it must be fitted with an effective protector. The mesh size of the guard must not affect the correct operation of the appliance.

1.6 GENERAL SERVICES

1.6.1 The Fume Channel/Combustion Air Intake

The combined fume channel and combustion air intake requires one of the following concentric flue system configurations.

Important:



Due to the high temperature of the outer walls (approx. 150°C), no flammable materials may be located or used in the vicinity of the flue system. The complete flue system, must therefore be sleeved with a heat resistant material after assembly.

Ventilate the covered concentric flue by fitting a grid near the floor and ceiling (on each floor).

Do not insulate the concentric flue.

Use the universal wall/floor support Ø150 mm to attach the covering of the concentric flue system [Ø100 mm - Ø150 mm], see 1.6.2, drawing number 36.

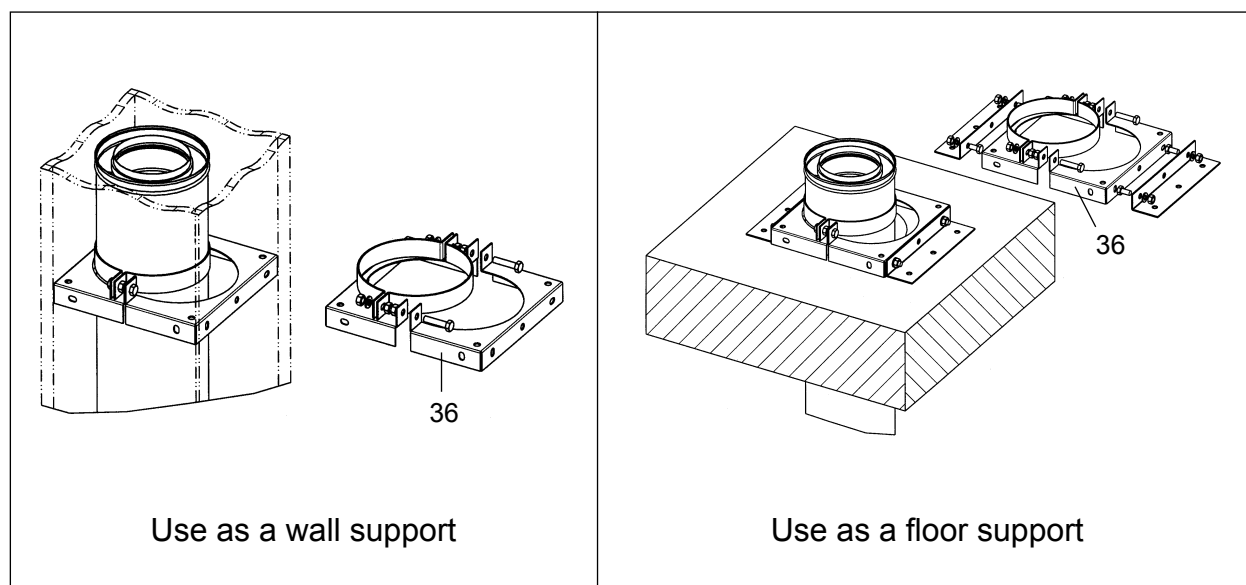
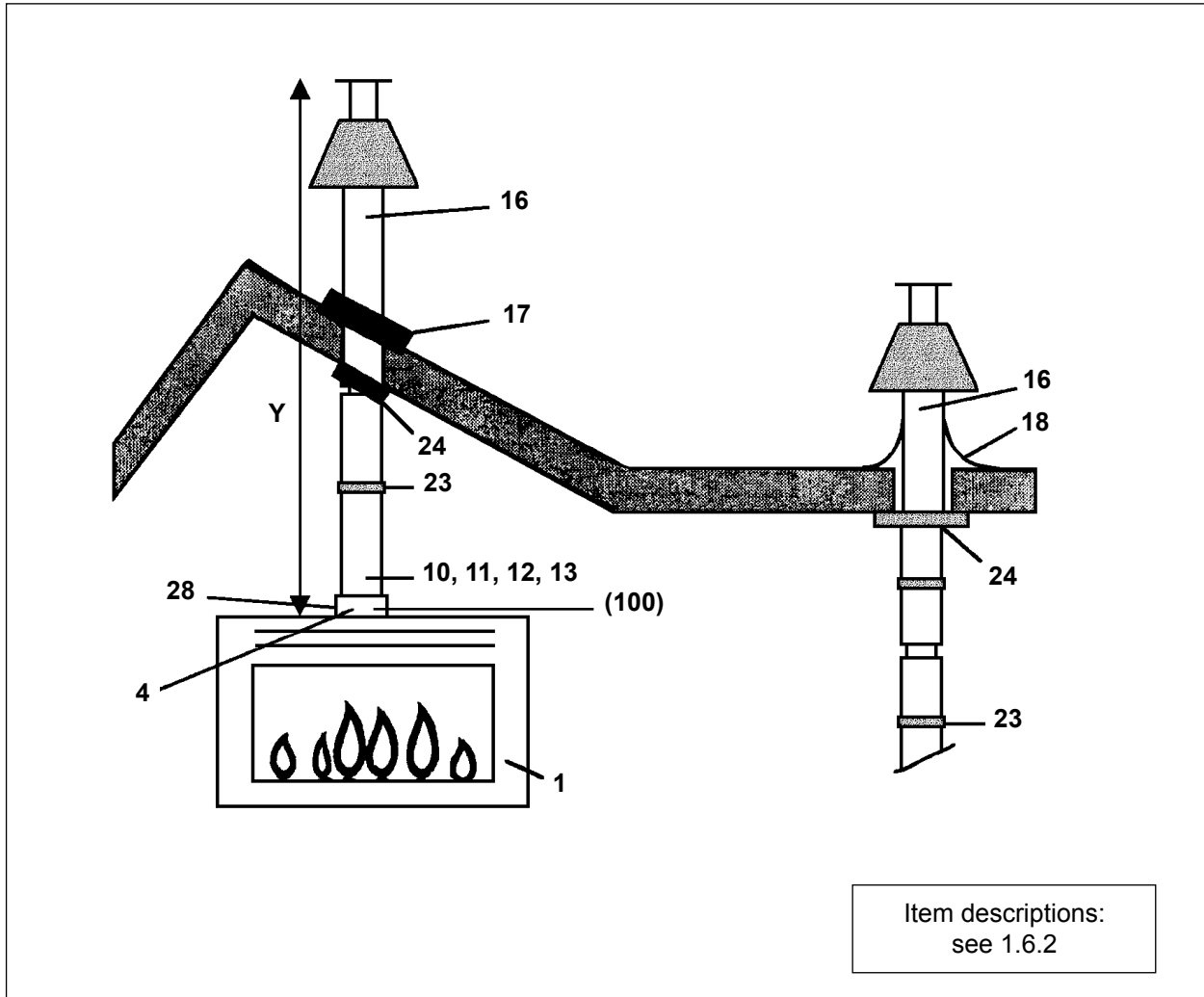

Figure 3: Application universal wall/floor support Ø150 mm

RIGID CONCENTRIC FLUE Ø100 mm - Ø150 mm SYSTEM CONNECTION POSSIBILITIES

Appliance: Concentric flue connection Ø100-Ø150 mm or Ø130-Ø200 mm



| Appliance: | Distance Y (min.-max.) | Assemble restriction plate: | |
|--------------|------------------------|--|--|
| | | Concentric connection on appliance is Ø100-Ø150 mm | Concentric connection on appliance is Ø130-Ø200 mm |
| York Large 3 | 2.0 - 4.0 m | Width: B = 30 mm | Width: B = 65 mm |
| | 4.0 - 12.0 m | Width: B = 40 mm | Width: B = 80 mm |

Figure 4: Vertical roof-mounted outlet without bend

ALL SIZES INCLUDE THE LENGTH OF THE ROOF OR WALL TERMINATION

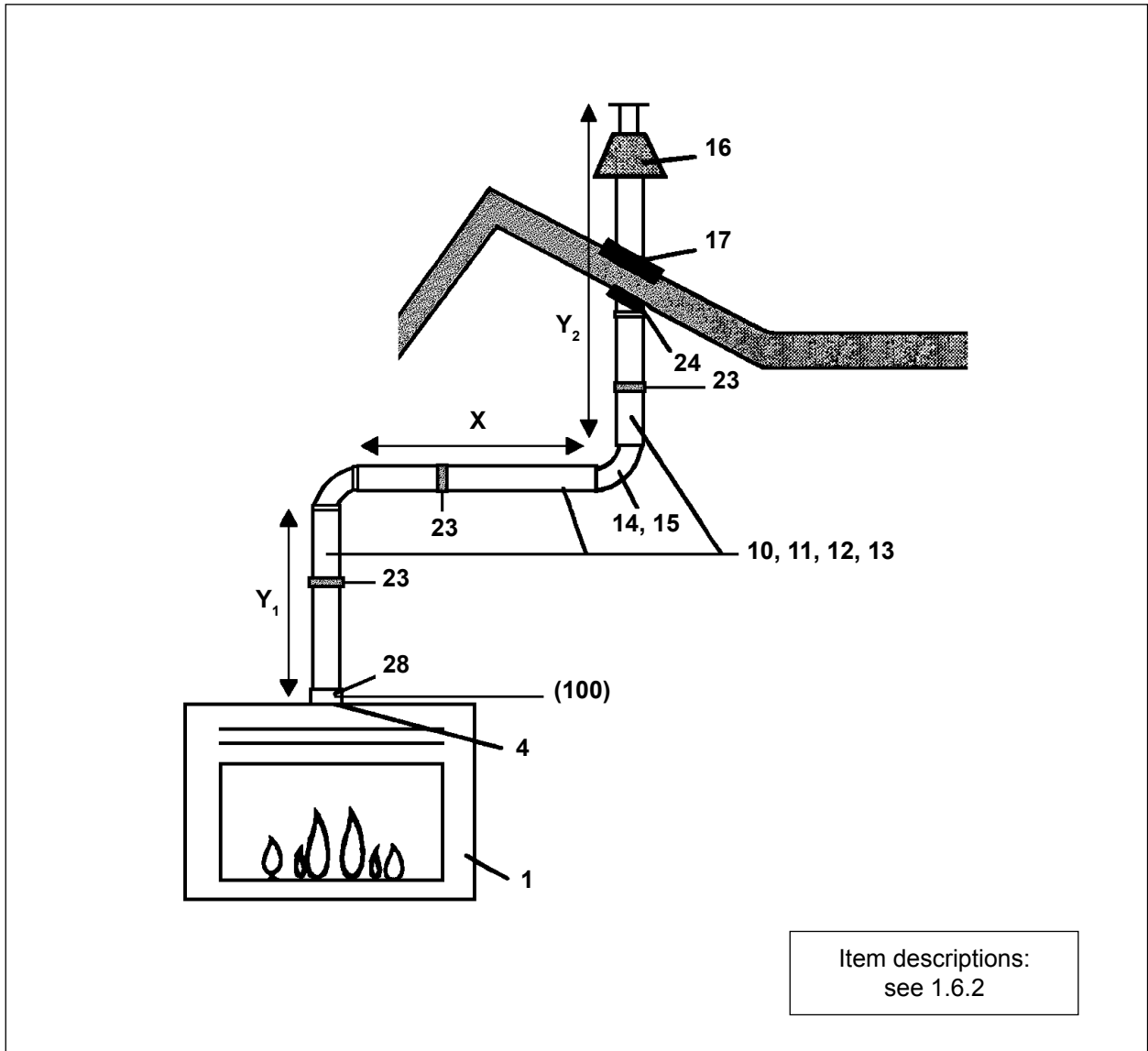

| Appliance: | Distance Y_1 (*) (min.-max.) | Distance X (*) (min.-max.) | Distance $Y_1 + Y_2$ (*) (min.-max.) | Assemble restriction plate: | |
|--------------|-----------------------------------|-------------------------------|---|--|--|
| | | | | Concentric connection on appliance is $\varnothing 100$ - $\varnothing 150$ mm | Concentric connection on appliance is $\varnothing 130$ - $\varnothing 200$ mm |
| York Large 3 | 1.0 - 11.0 m | 0 - 3.0 m | 1.0 - 11.0 m | - | Width: B = 40 mm |

(*) : $(Y_1 + Y_2) : X \geq 2 : 1$
 (Vertical to horizontal ratio (or 45° upwards) is always at least 2 to 1)

Figure 5: Vertical roof-mounted outlet with bend

ALL SIZES INCLUDE THE LENGTH OF THE ROOF OR WALL TERMINATION

FLEXIBLE CONCENTRIC FLUE Ø100 mm - Ø150 mm SYSTEM CONNECTION POSSIBILITIES

Appliance: Concentric flue connection Ø100-Ø150 mm or Ø130-Ø200 mm

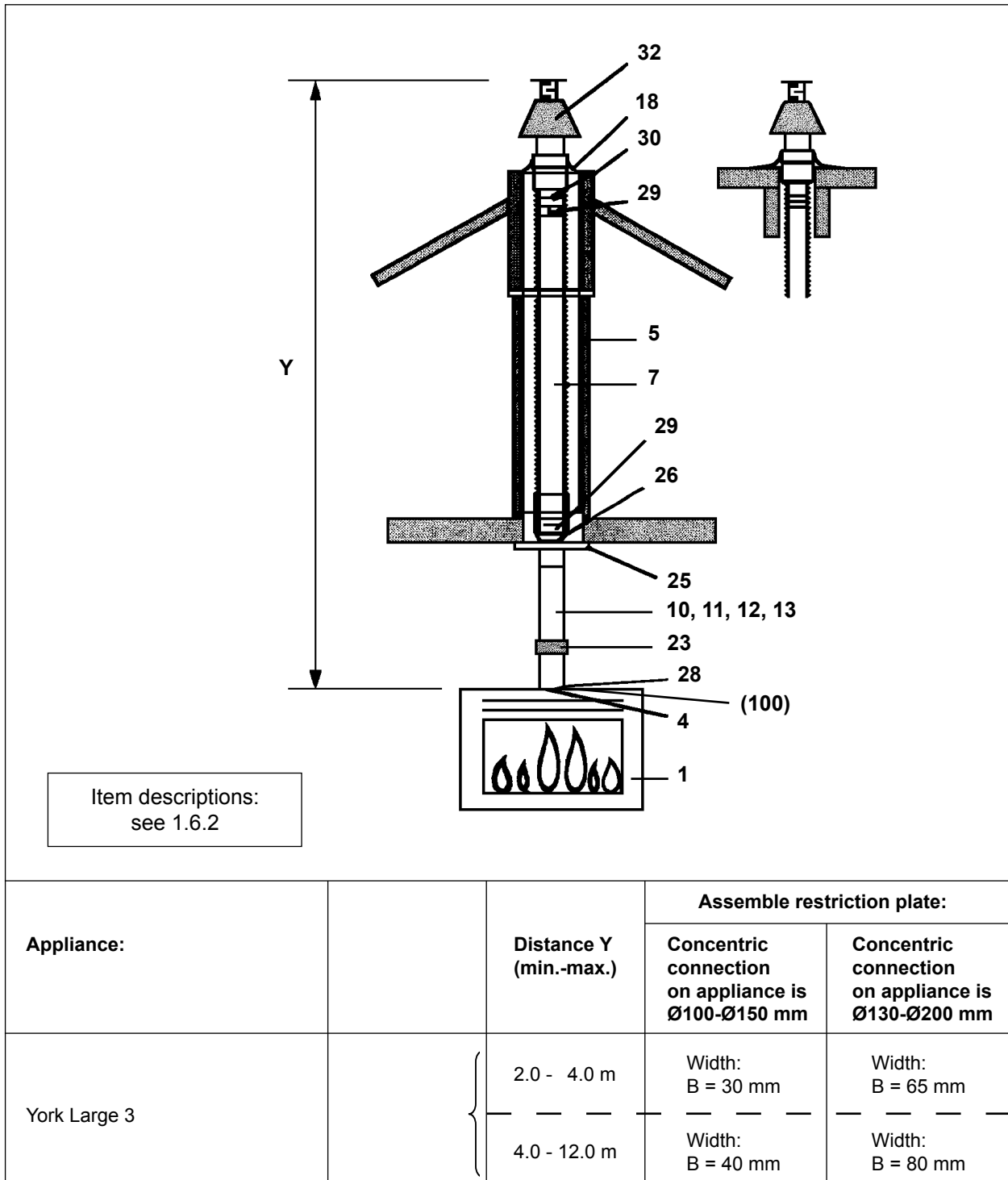
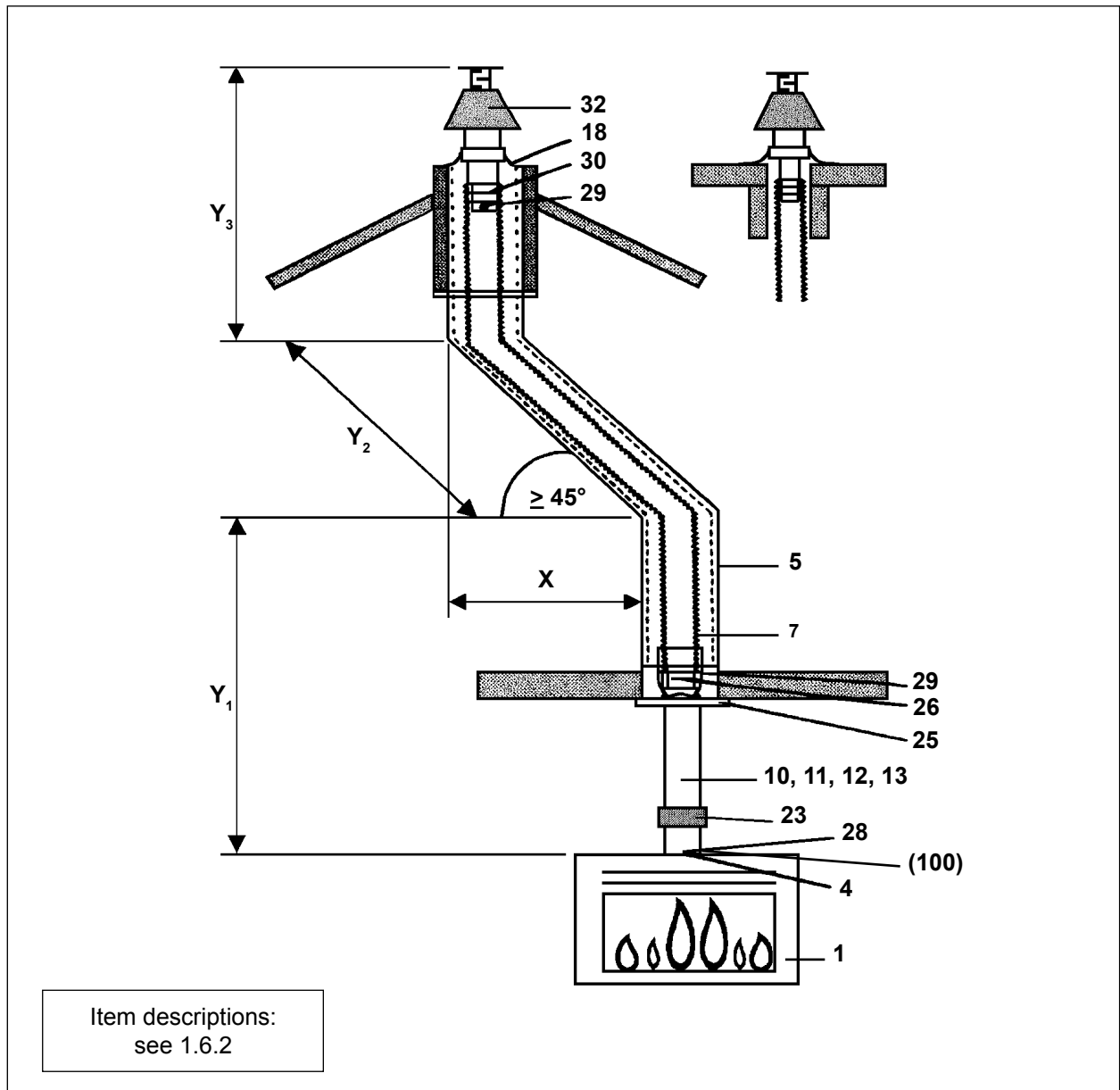

Figure 6: Vertical chimney outlet using an existing lined chimney
(Flexible Ø100 mm and/or rigid Ø100 mm / Ø150 mm)

ALL SIZES INCLUDE THE LENGTH OF THE ROOF OR WALL TERMINATION



| Appliance: | Distance Y ₁ (*) (min.-max.) | Distance X (*) (min.-max.) | Distance Y ₁ + Y ₂ + Y ₃ (*) (min.-max.) | Assemble restriction plate: | |
|--------------|--|-------------------------------|--|--|--|
| | | | | Concentric connection on appliance is Ø100-Ø150 mm | Concentric connection on appliance is Ø130-Ø200 mm |
| York Large 3 | 1.0 - 11.0 m | 0 - 3.0 m | 1.0 - 11.0 m | - | Width: B = 40 mm |

(*) : (Y₁ + Y₂ + Y₃) : X ≥ 2 : 1
(Vertical to horizontal ratio (or 45° upwards) is always at least 2 to 1)

Figure 7: Vertical chimney outlet using a lined chimney with a bend ≥ 45°
(Flexible Ø100 mm and/or rigid Ø100 mm / Ø150 mm)

ALL SIZES INCLUDE THE LENGTH OF THE ROOF OR WALL TERMINATION

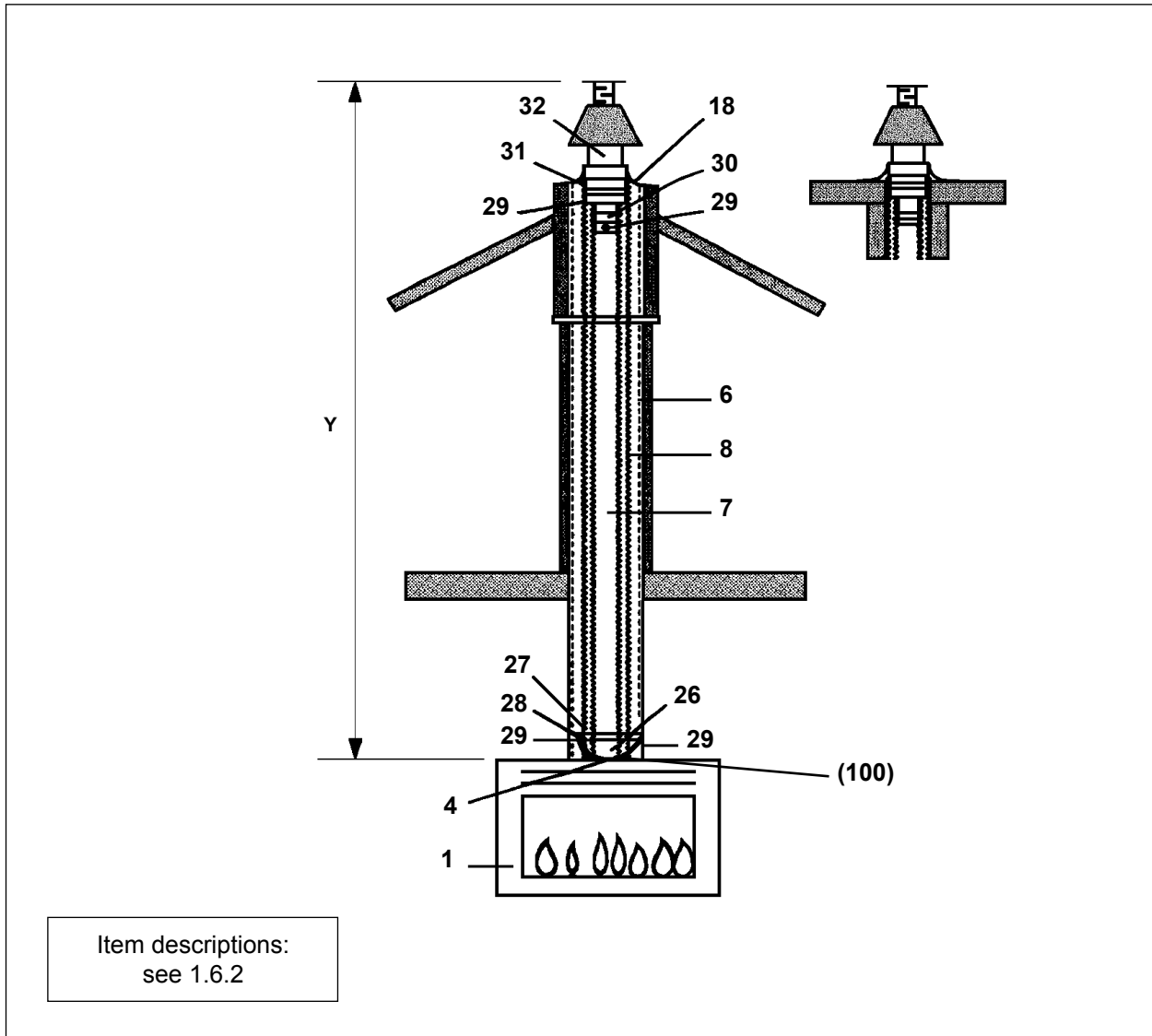

| Appliance: | Distance Y (min.-max.) | Assemble restriction plate: | |
|--------------|------------------------|--|--|
| | | Concentric connection on appliance is Ø100-Ø150 mm | Concentric connection on appliance is Ø130-Ø200 mm |
| York Large 3 | 2.0 - 4.0 m | Width: B = 30 mm | Width: B = 65 mm |
| | 4.0 - 12.0 m | Width: B = 40 mm | Width: B = 80 mm |

Figure 8: Vertical chimney outlet using an existing unsound lined chimney or when no chimney liners are present (Flexible Ø100 mm / Ø150 mm)

ALL SIZES INCLUDE THE LENGTH OF THE ROOF OR WALL TERMINATION

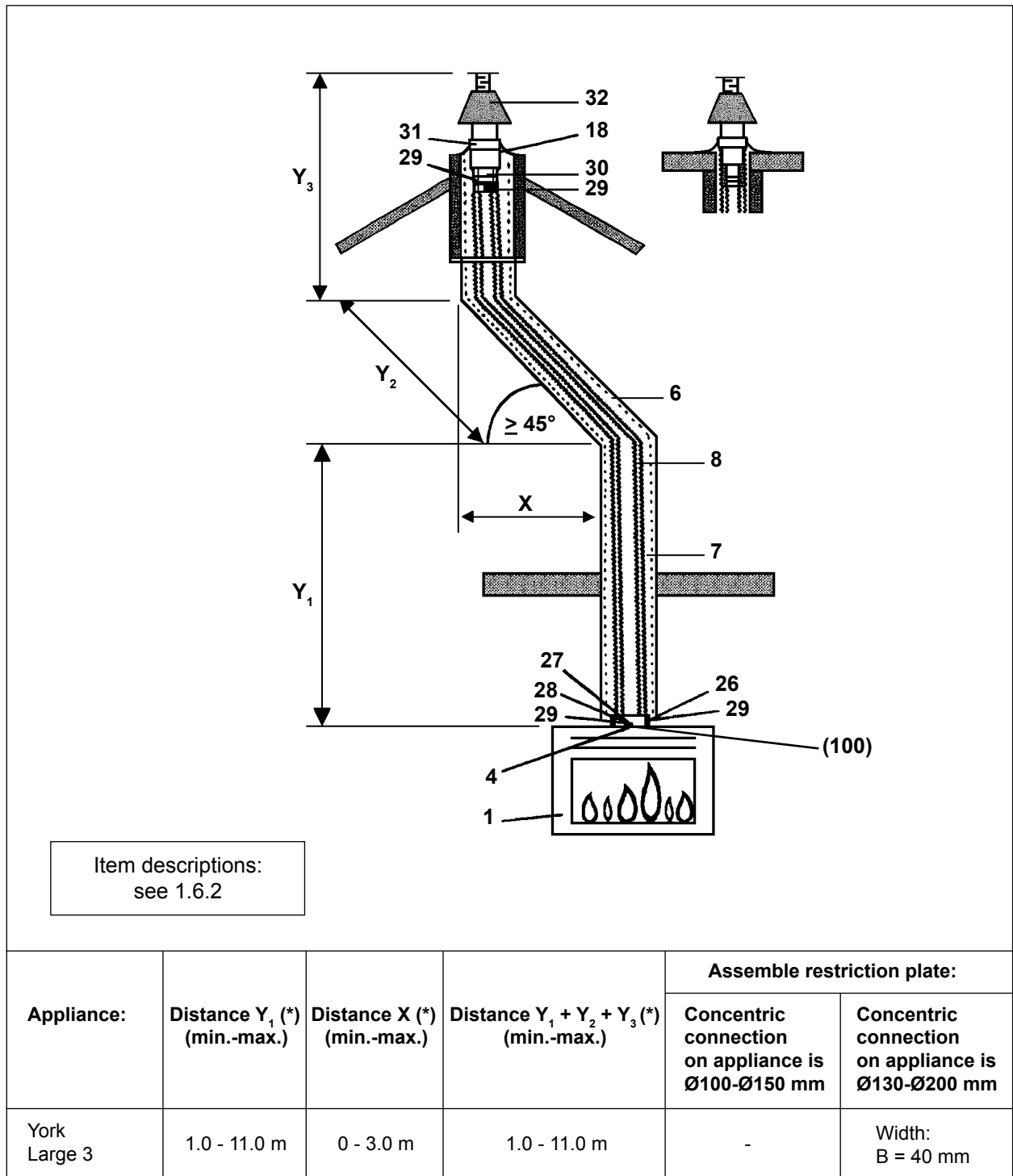

(*) : $(Y_1 + Y_2 + Y_3) : X \geq 2 : 1$
 (Vertical to horizontal ratio (or 45° upwards) is always at least 2 to 1)

Figure 9: Vertical chimney outlet using an existing unsound lined chimney or when the chimney is unlined; with a bend $\geq 45^\circ$ (Flexible $\text{Ø}100$ mm / $\text{Ø}150$ mm)

ALL SIZES INCLUDE THE LENGTH OF THE ROOF OR WALL TERMINATION

RIGID CONCENTRIC FLUE Ø100 mm - Ø150 mm SYSTEM CONNECTION
POSSIBILITIES and with wall outlet Ø100 mm - Ø150 mm

Appliance: Concentric flue connection Ø100-Ø150 mm or Ø130-Ø200 mm

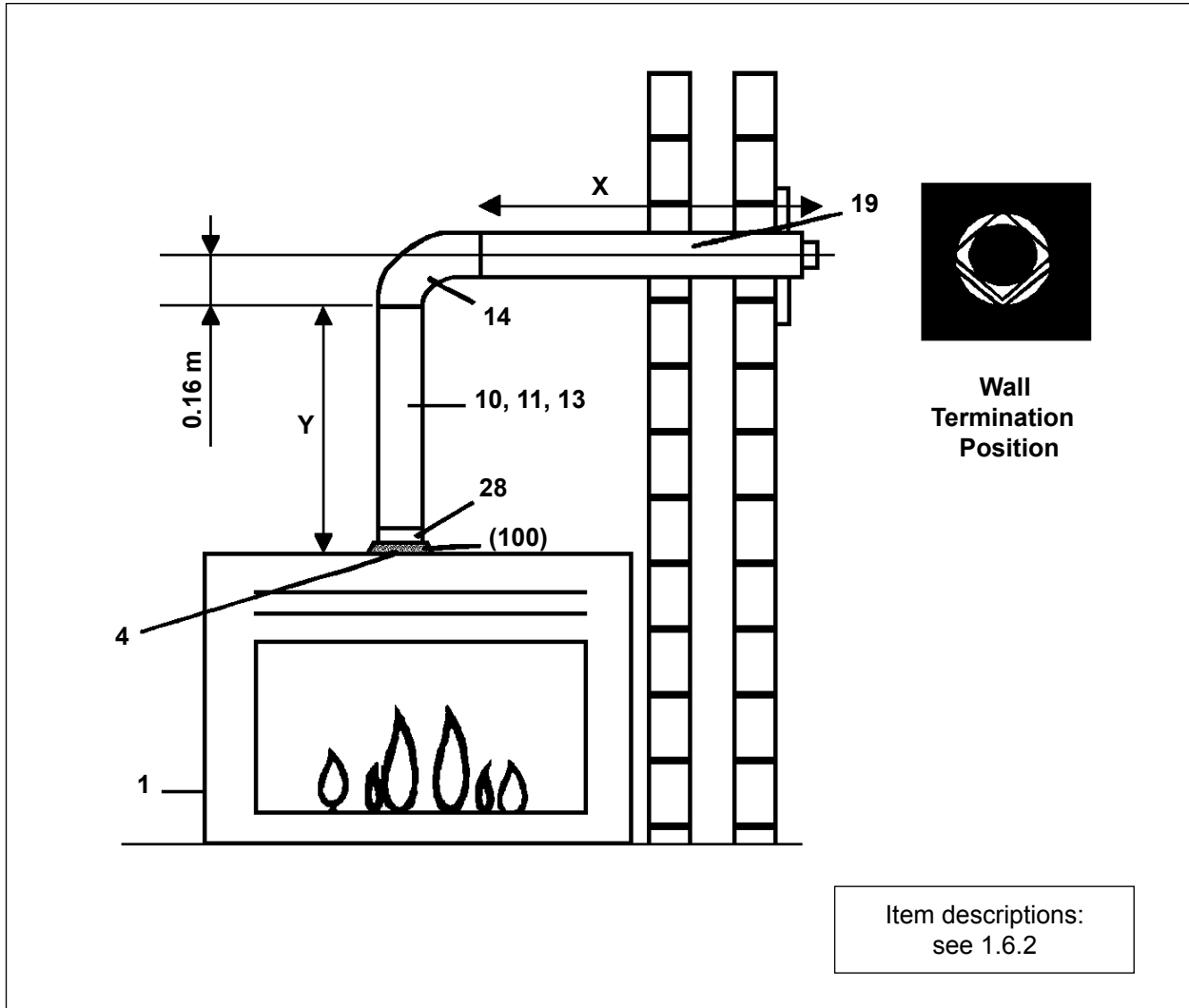

| Appliance: | Distance Y (min.-max.) | Distance X (min.-max.) | Assemble restriction plate: | |
|--------------|---------------------------|---------------------------|--|--|
| | | | Concentric connection on appliance is Ø100-Ø150 mm | Concentric connection on appliance is Ø130-Ø200 mm |
| York Large 3 | 2.0 - 3.0 m | 0 - 0.6 m | - | - |
| | 3.0 - 4.0 m | 0 - 1.6 m | - | - |

Figure 10: Horizontal wall termination

ALL SIZES INCLUDE THE LENGTH OF THE ROOF OR WALL TERMINATION

RIGID CONCENTRIC FLUE Ø130 mm - Ø200 mm SYSTEM CONNECTION
POSSIBILITIES and with wall outlet Ø100 mm - Ø150 mm

Appliance: Concentric flue connection Ø130-Ø200 mm

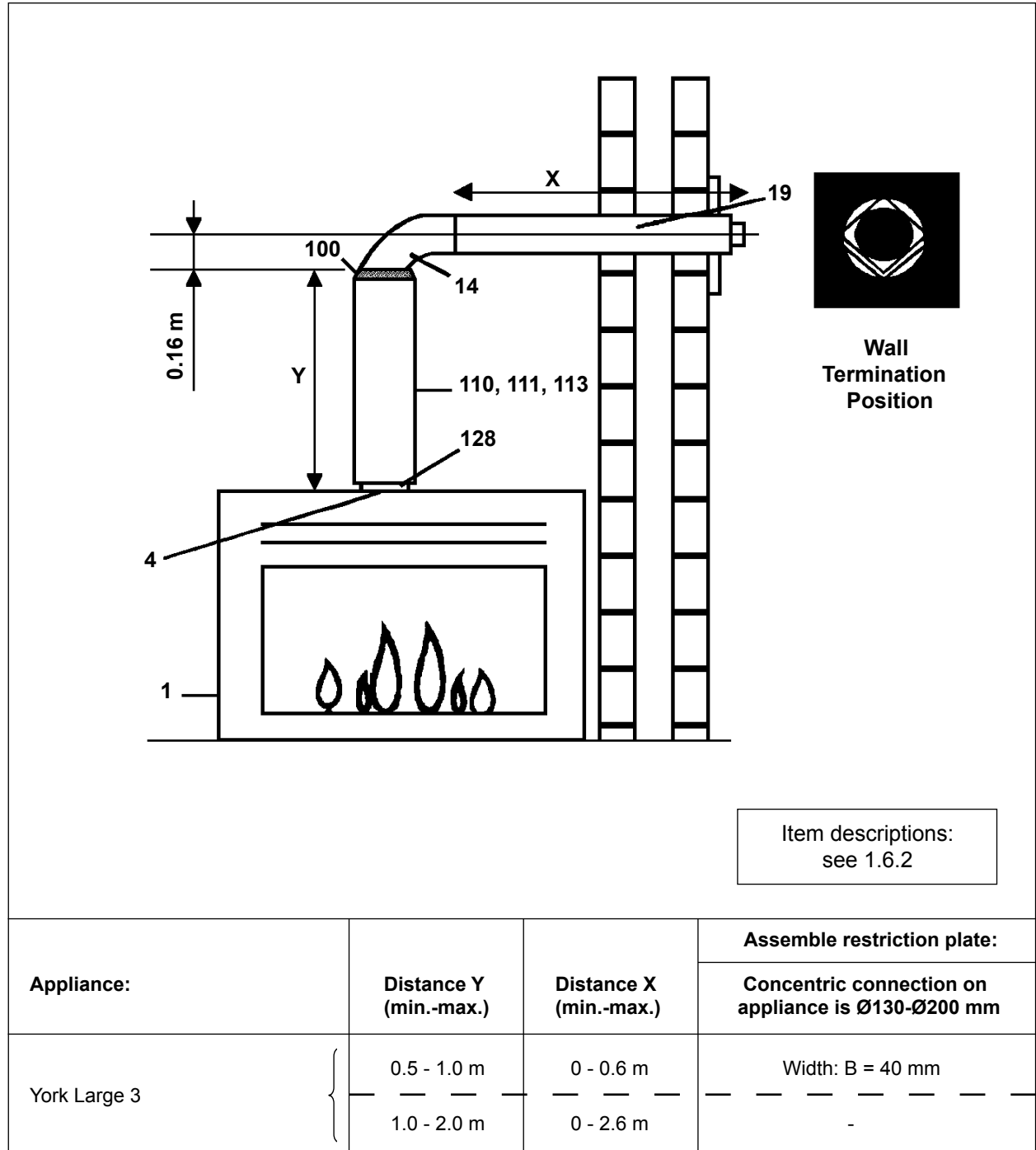

Figure 11: Horizontal wall termination

ALL SIZES INCLUDE THE LENGTH OF THE ROOF OR WALL TERMINATION

RIGID CONCENTRIC FLUE Ø130 mm - Ø200 mm SYSTEM CONNECTION
POSSIBILITIES and with wall outlet Ø100 mm - Ø150 mm

Appliance: Concentric flue connection Ø130-Ø200 mm

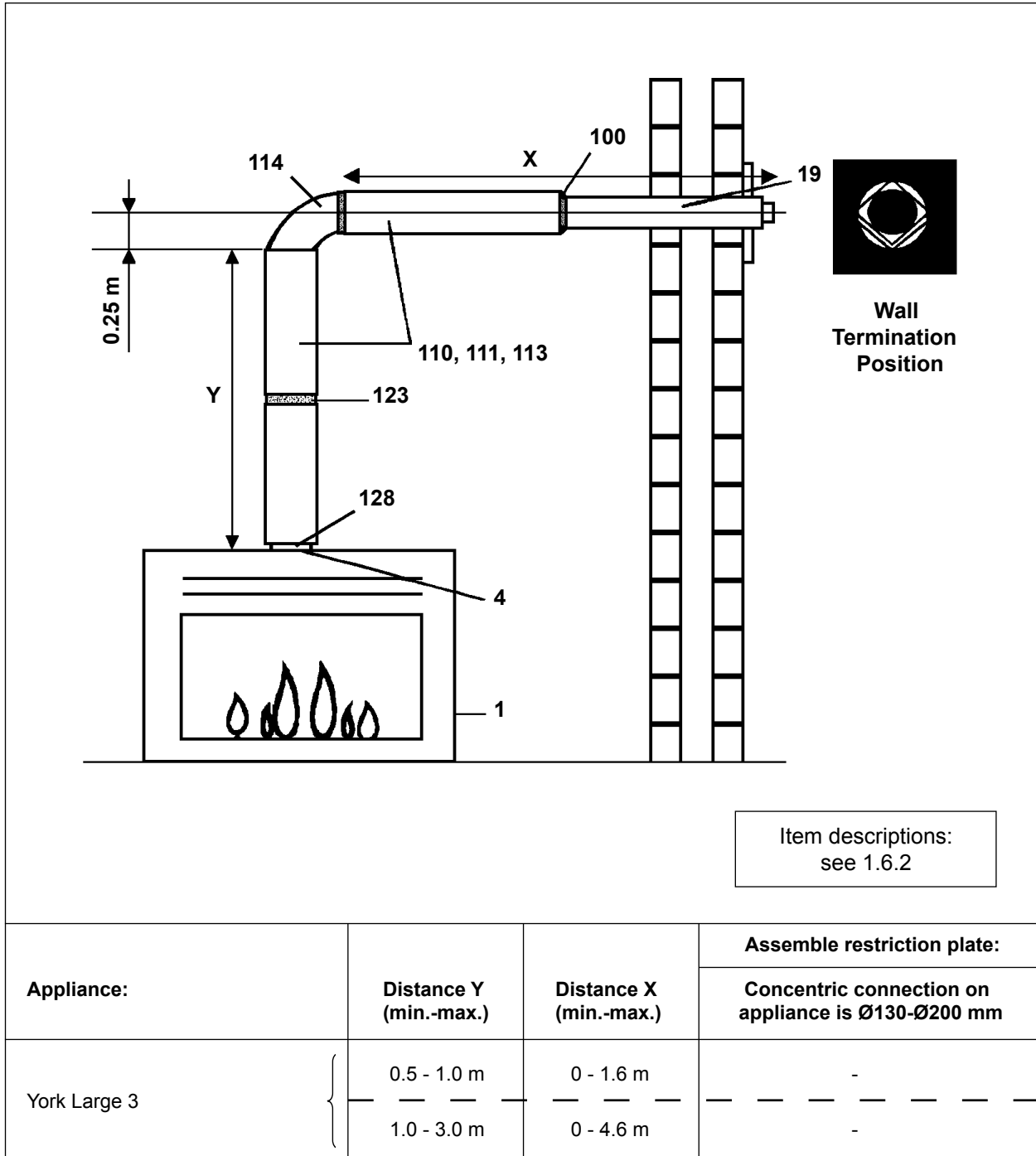
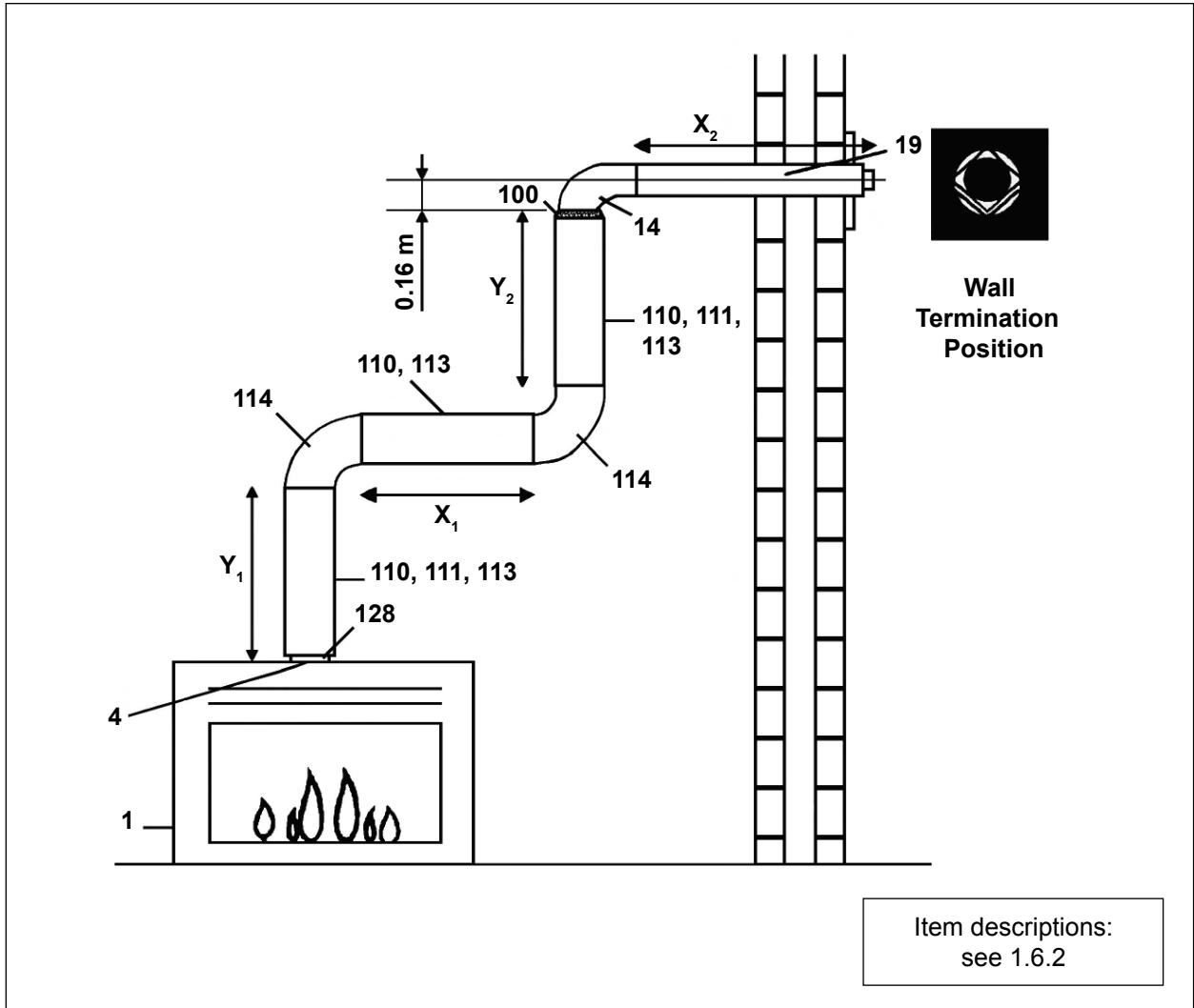

Figure 12: Horizontal wall termination

ALL SIZES INCLUDE THE LENGTH OF THE ROOF OR WALL TERMINATION

RIGID CONCENTRIC FLUE Ø130 mm - Ø200 mm SYSTEM CONNECTION
POSSIBILITIES and with wall outlet Ø100 mm - Ø150 mm

Appliance: Concentric flue connection Ø130-Ø200 mm



| Appliance: | Distance Y ₁ (min.-max.) | Distance X ₁ (min.-max.) | Distance Y ₂ (min.-max.) | Distance X ₂ (min.-max.) | Assemble restriction plate: |
|-----------------|--|--|--|--|--|
| | | | | | Concentric connection on appliance is Ø130-Ø200 mm |
| York Large 3 | 0 - 0.5 m | 0 - 0.5 m | 0.5 - 1.0 m | 0 - 0.6 m | - |
| | 0.5 - 1.0 m | 0 - 0.5 m | 0 - 0.5 m | 0 - 0.6 m | - |
| | 1.0 - 3.0 m | 0 - 1.0 m | 0.5 - 2.0 m | 0 - 0.6 m | - |
| | 1.0 - 3.0 m | 0 - 3.0 m | 1.0 - 3.0 m | 0 - 0.6 m | - |

Figure 13: Horizontal wall termination

ALL SIZES INCLUDE THE LENGTH OF THE ROOF OR WALL TERMINATION

RIGID CONCENTRIC FLUE Ø130 mm - Ø200 mm SYSTEM CONNECTION
POSSIBILITIES and with wall outlet Ø130 mm - Ø200 mm

Appliance: Concentric flue connection Ø130-Ø200 mm

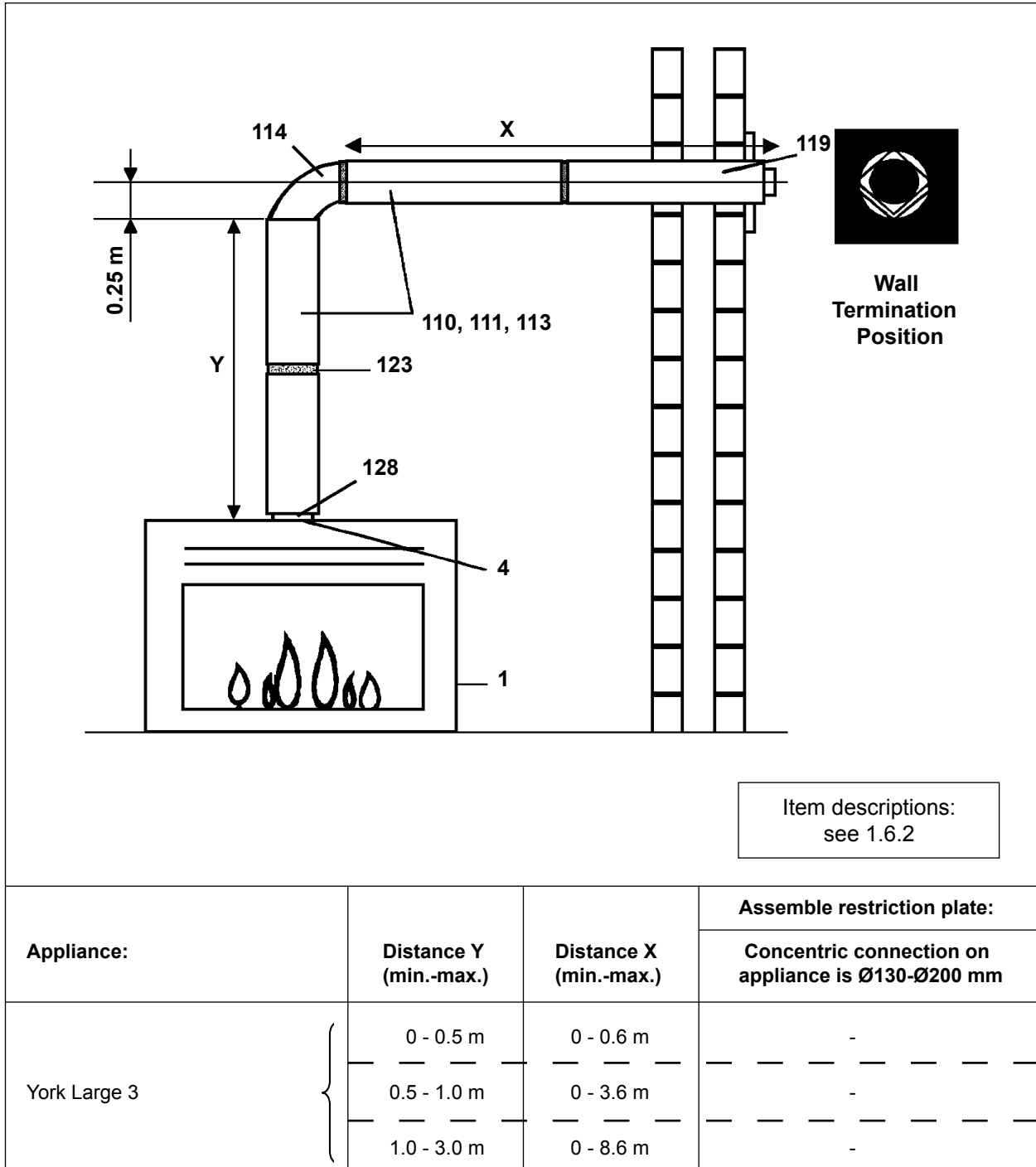







Figure 14: Horizontal wall termination







ALL SIZES INCLUDE THE LENGTH OF THE ROOF OR WALL TERMINATION





1.6.2 Item descriptions for figures 4 t/m 14

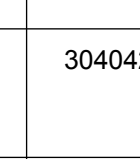
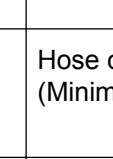
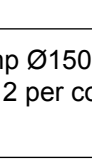
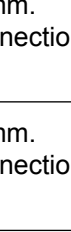

| FIG. NO. | DESCRIPTION |
|----------|--|
| 1 | Gas fire; Concentric flue connection Ø130/Ø200 mm or Ø100/Ø150 mm |
| 2 | - |
| 3 | - |
| 4 | Restriction plate (The different sizes restriction plates are supplied with every appliance) |
| 5 | Chimney, min. Ø150 mm internal, totally gas tight. |
| 6 | Chimney or fireproof sleeving. Min. Ø160 mm internal. |
| 7 | Ø100 mm internal flexible stainless steel gas vent chimney liner AISI 316TI. |
| 8 | Ø150 mm internal flexible stainless steel gas vent chimney liner AISI 316TI. |
| 9 | - |

AVAILABLE COMPONENTS FOR THE BELLFIRES (M&G) CONCENTRIC FLUE SYSTEM Ø100 mm - Ø150 mm

| FIG. NO. | BELLFIRES ART. / ORDER NO. | DESCRIPTION | | Color(*) | | Application | |
|----------|----------------------------|--|---|----------|-------|-------------|------|
| | | | | RVS | antr. | RIGID | FLEX |
| 10 | 302289 | Twin-wall balanced flue pipe, L = 500 mm, incl. ① and ② |  | • | | • | |
| 11 | 302290 | Twin-wall balanced flue pipe, L = 1000 mm, incl. ① and ② |  | • | | • | |
| 12 | 302291 | Telescopic twin-wall balanced flue pipe, L = min. 325 / max. 440 mm, incl. ① and ② |  | • | | • | |
| 13 | 302292 | Adjustable length twin-wall balanced flue pipe, L = 500 mm, incl. ① and ② |  | • | | • | |
| 14 | 302297 | Twin-wall balanced flue elbow 90°, incl. ① and ② |  | • | | • | |

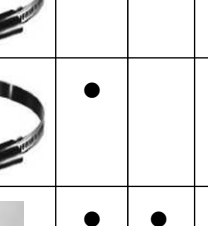
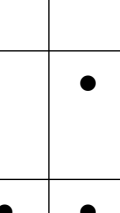
| FIG. NO. | BELLFIRES ART. / ORDER NO. | DESCRIPTION | | Color(*) | | Application | |
|----------|----------------------------|---|--|----------|-------|-------------|------|
| | | | | RVS | antr. | RIGID | FLEX |
| 15 | 302298 | Twin-wall balanced flue elbow 45°, incl. ① and ② |  | ● | | ● | |
| 16 | 302295 | Vertical (roof) termination kit, L = 1360 mm (vertical), incl. ①, ② and ④ |  | ● | ● | ● | ● |
| 17 | 302212 | Adjustable roof flashing. Roof pitch 20° - 45° (**), with lead flashing |  | ● | | ● | ● |
| 18 | 302213 | Roof flashing for existing chimney or flat roof |  | ● | | ● | ● |
| 19 | 302296 | Horizontal (wall) termination kit, L = 600 mm (horizontally adjustable), incl. ①, ② and one set of wall spacer plates |  | ● | ● | ● | ● |
| 20 | 302293 | ① : Stainless steel locking band Ø150 mm, quick-fastening |  | ● | | ● | ● |
| 21 | 302210 | ② : Silicone seal Ø150 mm | | | | ● | ● |
| 23 | 302215 | ④ : Wall strap | | ● | | ● | ● |
| 24 | 302214 | Set of ceiling finishing plates / Fire stops |  | ● | | ● | ● |

| FIG. NO. | BELLFIRES ART. / ORDER NO. | DESCRIPTION |  | Color(*) | | Application | |
|----------|----------------------------|---|---|----------|-------|-------------|------|
| | | | | RVS | antr. | RIGID | FLEX |
| 25 | 302189 | Ceiling plate for transition Ø100 mm / Ø150 mm rigid - Ø100 mm (flex.). |  | • | | • | • |
| 26 | 302278 | Stainless steel adapter piece (100) from fire to flexible, Ø100 mm external (rigid) x Ø107 mm internal (flex.). [appliance - Ø100 mm flex.] and [Ø100 mm rigid - Ø100 mm flex.]. |  | • | | | • |
| 27 | 302279 | Stainless steel adapter piece (150) fire to flexible, Ø148 mm external (rigid) x Ø148 mm internal (flex.) [appliance - Ø150 mm flex.]. |  | • | | | • |
| 28 | 302217 | Stainless steel locking band Ø150 mm. For adapter 150 [appliance - Ø150 mm (flex.)], Screw-fastening |  | • | | • | • |
| 29 | 303776 | Stainless steel screws Ø3.5 mm x 9.5 mm. For securing the flexible concentric flue. (Minimum 3 screws per connection) |  | • | | | • |
| 30 | 304041 | Hose clamp Ø100 mm. (Minimum 2 per connection) |  | • | | | • |
| 31 | 304042 | Hose clamp Ø150 mm. (Minimum 2 per connection) |  | • | | | • |
| 32 | 302307 | Vertical (roof) termination kit, L = 610 mm (vertical), incl. ① and ②. For the flexible flue system. |  | • | • | • | • |
| 33 | 302301 | Concentric T-piece with gauging orifice, incl. ① and ② |  | • | | • | |

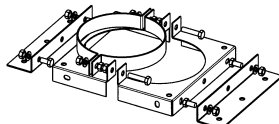





| FIG. NO. | BELLFIRES ART. / ORDER NO. | DESCRIPTION | | Color(*) | | Application | |
|----------|----------------------------|---|---|----------|-------|-------------|------|
| | | | | RVS | antr. | RIGID | FLEX |
| 34 | 302302 | Concentric pipe with gauging orifice, L = 165 mm, incl. ① and ② |  | ● | | ● | |
| 35 | 302303 | 90° concentric bend with inspection panel, incl. ① and ② |  | ● | | ● | |
| 36 | 321948 | Universal wall / floor support Ø150 mm |  | ● | | ● | |







(*) : Color : RVS : Stainless steel self-colour, polished
 antr. : Anthracite colour lacquer, matt

(**) : Adjustable roof flashing for a slope > 45° can be supplied on request.







When installing a balanced-flue “closed” gas fire in an existing chimney, ensure stainless steel flexible liners (Ø100 mm or Ø130 mm) conforming with BS 316 are used to conduct the spent gases.







**AVAILABLE COMPONENTS FOR THE BELLFIRES (M&G) CONCENTRIC
FLUE SYSTEM Ø130 mm - Ø200 mm**



| FIG NO. | BELLFIRES ART. / ORDER NO. | DESCRIPTION | | Color(*) | | Application | |
|---------|----------------------------|--|--|----------|-------|-------------|------|
| | | | | RVS | antr. | RIGID | FLEX |
| 100 | 302319 | Concentric reduction of Ø130 / Ø200 mm → Ø100 / Ø150 mm |  | • | | • | • |
| 110 | 302308 | Twin-wall balanced flue pipe, L= 500 mm, incl. ⑤ and ⑥ |  | • | | • | |
| 111 | 302309 | Twin-wall balanced flue pipe, L= 1000 mm, incl. ⑤ and ⑥ |  | • | | • | |
| 113 | 302310 | Adjustable length twin-wall balanced flue pipe, L= 500 mm, incl. ⑤ and ⑥ |  | • | | • | |
| 114 | 302314 | Twin-wall balanced flue elbow 90°, incl. ⑤ and ⑥ |  | • | | • | |
| 115 | 302315 | Twin-wall balanced flue elbow 45°, incl. ⑤ and ⑥ |  | • | | • | |
| 119 | 302313 | Horizontal (wall) termination kit, L= 600 mm (horizontally adjustable), incl. ⑤, ⑥ and one set of wall spacer plates |  | • | • | • | |





| FIG. NO. | BELLFIRES ART. / ORDER NO. | DESCRIPTION | | Color(*) | | Application | |
|----------|----------------------------|---|--|----------|-------|-------------|------|
| | | | | RVS | antr. | RIGID | FLEX |
| 120 | 302311 | ⑤ : Stainless steel locking band Ø200 mm, quick-fastening |  | • | | • | • |
| 121 | 302248 | ⑥ : Silicone seal Ø200 mm | | | | • | • |
| 123 | 302251 | ⑧ : Wall strap | | | | • | • |
| 124 | 302250 | Set of ceiling finishing plates / Fire stops |  | • | | • | • |
| 126 | 302281 | Stainless steel adapter piece (130) from fire to flexible, Ø130 mm external (rigid) x Ø137 mm internal (flex.), [appliance - Ø130 mm flex.] and [Ø130 mm rigid - Ø130 mm flex.] |  | • | | | • |
| 127 | 302282 | Stainless steel adapter piece (200) from fire to flexible, Ø198 mm external (rigid) x Ø198 mm internal (flex.), [appliance - Ø200 mm flex.] |  | • | | | • |
| 128 | 302257 | Stainless steel locking band Ø200 mm. For adapter 200. [appliance - Ø200 mm flex.]. Screw-fastening | | • | | • | • |
| 129 | 303776 | Stainless steel screws Ø3.5 mm x 9.5 mm. For securing the flexible concentric flue. (Minimum 3 screws per connection) |  | • | | | • |
| 130 | 304045 | Hose clamp Ø130 mm. (Minimum 2 per connection) |  | • | | | • |
| 131 | 304046 | Hose clamp Ø200 mm. (Minimum 2 per connection) |  | • | | | • |

**AVAILABLE COMPONENTS FOR THE POUJOLAT PGI CONCENTRIC
FLUE SYSTEM Ø100 mm - Ø150 mm**

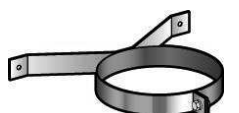
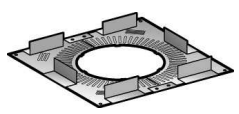
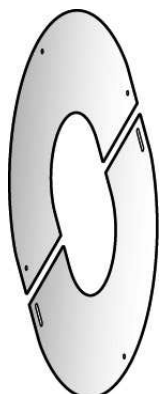
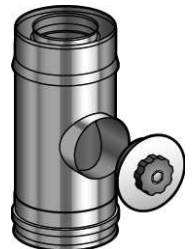

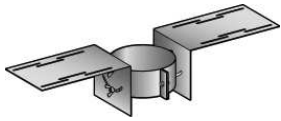
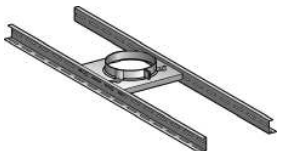



| FIG. NO. | POUJOLAT ART. / ORDER NO. | DESCRIPTION | |
|----------|---------------------------|---|---|
| | 37100403 | Twin-wall balanced flue pipe, L = 250 mm |  |
| 10 | 37100404 | Twin-wall balanced flue pipe, L = 450 mm |  |
| 11 | 37100405 | Twin-wall balanced flue pipe, L = 950 mm |  |
| 12 | 37100429 | Telescopic twin-wall balanced flue pipe, L = min. 390 mm / max. 640 mm |  |
| 14 | 37100441 | Twin-wall balanced flue elbow 90° |  |
| 15 | 37100421 | Twin-wall balanced flue elbow 45° |  |





| FIG. NO. | POUJOLAT ART. / ORDER NO. | DESCRIPTION | |
|----------|---------------------------|--|---|
| | 37100411 | Twin-wall balanced flue elbow 30° |  |
| | 37100401 | Twin-wall balanced flue elbow 15° |  |
| 16 | 37100654 | Vertical (roof) termination kit, L = 140 mm |  |
| 17 | 45150171 | Roof flashing, suitable for a brick roof, with a roof pitch of 15° - 30° |  |
| | 45150170 | Roof flashing, suitable for a tiled roof, with a roof pitch of 15° - 30° |  |
| | 45150172 | Roof flashing, suitable for a brick roof, with a roof pitch of 30° - 45° |  |
| | 45150173 | Roof flashing, suitable for a tiled roof, with a roof pitch of 30° - 45° |  |



| FIG. NO. | POUJOLAT ART. / ORDER NO. | DESCRIPTION | |
|----------|---------------------------|--|---|
| 18 | 45150169 | Roof flashing for existing chimney or flat roof |  |
| 19 | 37100610 | Horizontal (wall) termination kit, L = min. 365 mm / max. 585 mm |  |
| 20 | 45150076 | Stainless steel locking band Ø150 mm, quick-fastening |  |
| 23 | 45150072 | Wall strap, Ø150 mm |  |
| 24 | 37100442 | Ceiling/wall plate with spacers and ventilation grooves |  |
| | 37100425 | Set of ceiling finishing plates / Fire stops, suitable for a roof pitch of 0° - 10° |  |
| | 37100426 | Set of ceiling finishing plates / Fire stops, suitable for a roof pitch of 10° - 30° | |
| | 37100427 | Set of ceiling finishing plates / Fire stops, suitable for a roof pitch of 30° - 40° | |
| | 37100428 | Set of ceiling finishing plates / Fire stops, suitable for a roof pitch of 40° - 50° | |
| 34 | 37100407 | Concentric pipe with inspection opening, L = 250 mm |  |

| FIG. NO. | POUJOLAT ART. / ORDER NO. | DESCRIPTION | |
|----------|---------------------------|--|---|
| 36 | 45150165 | Roof support, (universal) Ø150 mm |  |
| 36 | 45150081 | Floor support, (universal) Ø150 mm |  |
| 37 | 37100611 | Adapter: Bellfires Ø100-150 mm → Pougoulat PGI Ø100-150 mm (Appliance 100/150 → Pougoulat PGI 100/150) |  |
| 100 | 37100614 | Adapter: Bellfires Ø130-200 mm → Pougoulat PGI Ø100-150 mm (Appliance 130/200 → Pougoulat PGI 100/150) |  |
| 101 | 37100613 | Concentric reduction of Pougoulat PGI Ø130-200 mm → Pougoulat PGI Ø100-150 mm |  |



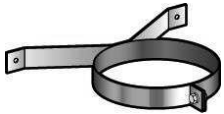
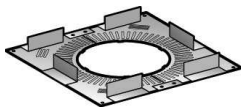
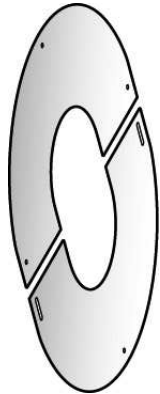

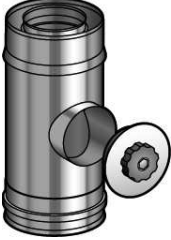
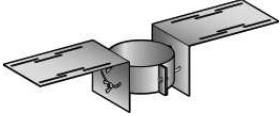
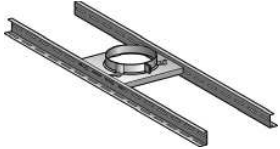
**AVAILABLE COMPONENTS FOR THE POUJOLAT PGI CONCENTRIC
FLUE SYSTEM Ø130 mm - Ø200 mm**

| FIG. NO. | POUJOLAT ART. / ORDER NO. | DESCRIPTION | |
|----------|---------------------------|---|---|
| | 37130403 | Twin-wall balanced flue pipe, L = 250 mm |  |
| 110 | 37130404 | Twin-wall balanced flue pipe, L = 450 mm |  |
| 111 | 37130405 | Twin-wall balanced flue pipe, L = 950 mm |  |
| 112 | 37130429 | Telescopic twin-wall balanced flue pipe, L = min. 390 mm / max. 640 mm |  |
| 114 | 37130441 | Twin-wall balanced flue elbow 90° |  |
| 115 | 37130421 | Twin-wall balanced flue elbow 45° |  |

| FIG. NO. | POUJOLAT ART. / ORDER NO. | DESCRIPTION | |
|----------|---------------------------|---|---|
| | 37130411 | Twin-wall balanced flue elbow 30° |  |
| 115 | 37130401 | Twin-wall balanced flue elbow 15° |  |
| 119 | 37130610 | Horizontal (wall) termination kit, L = min. 425 mm / max. 585 mm |  |
| 120 | 45200076 | Stainless steel locking band Ø200 mm, quick-fastening |  |
| 123 | 45200072 | Wall strap, Ø200 mm |  |
| 124 | 37130442 | Ceiling/wall plate with spacers and ventilation grooves |  |
| | 37130425 | Set of ceiling finishing plates / Fire stops, suitable for a roof pitch of 0°- 10° |  |
| | 37130426 | Set of ceiling finishing plates / Fire stops, suitable for a roof pitch of 10°- 30° | |
| | 37130427 | Set of ceiling finishing plates / Fire stops, suitable for a roof pitch of 30°- 40° | |
| | 37130428 | Set of ceiling finishing plates / Fire stops, suitable for a roof pitch of 40°- 50° | |

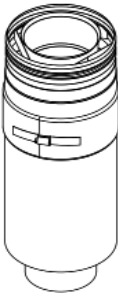
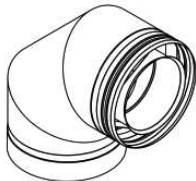

| FIG. NO. | POUJOLAT ART. / ORDER NO. | DESCRIPTION | |
|----------|---------------------------|---|---|
| | 37130407 | Concentric pipe with inspection opening, L = 250 mm |  |
| | 45200165 | Roof support, (universal) Ø200 mm |  |
| | 45200081 | Floor support, (universal) Ø200 mm |  |
| | 37130615 | Adapter: Bellfires Ø130-200 mm → Pujoulat PGI Ø130-200 mm (Appliance 130/200 → Pujoulat PGI 130/200) |  |

AVAILABLE COMPONENTS FOR THE ONTOP METALOTERM US CONCENTRIC FLUE SYSTEM Ø100 mm - Ø150 mm

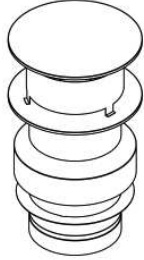
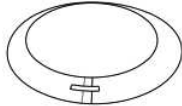
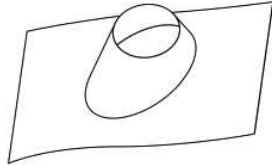
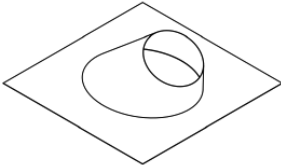
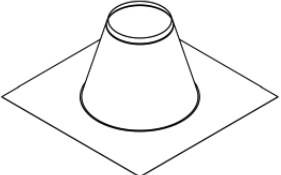
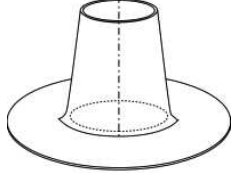
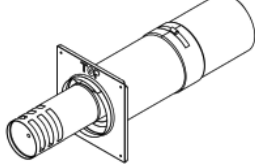
| FIG. NO. | ONTOP ART. / ORDER NO. | DESCRIPTION | |
|----------|------------------------|--|---|
| | USA 10 | Adapter for Bellfires appliances with Ø100-Ø150 mm concentric connection |  |
| | US 25 10 | Twin-wall balanced flue pipe, L = 250 mm |  |
| 10 | US 50 10 | Twin-wall balanced flue pipe, L = 500 mm | |
| 11 | US 100 10 | Twin-wall balanced flue pipe, L = 1000 mm | |
| 12 | USPP 10 | Telescopic twin-wall balanced flue pipe, L = min. 60 / max. 250 mm |  |
| 14 | USB 90 10 | Twin-wall balanced flue elbow 90° |  |
| 15 | USB 45 10 | Twin-wall balanced flue elbow 45° |  |
| | USB 30 10 | Twin-wall balanced flue elbow 30° |  |

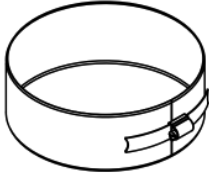
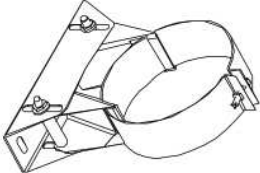
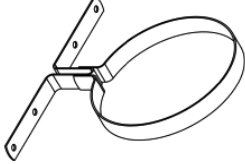
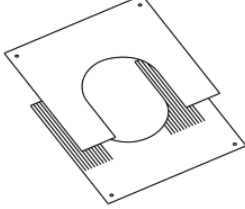
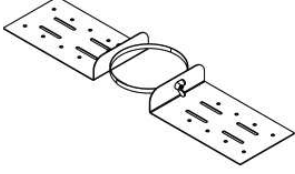
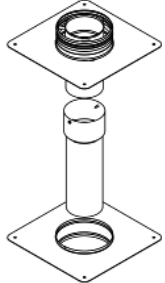
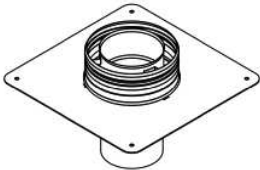

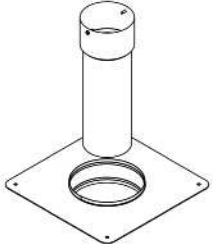
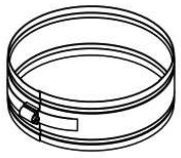
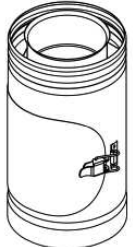
| FIG. NO. | ONTOP ART. / ORDER NO. | DESCRIPTION | |
|----------|------------------------|--|---|
| | USB 15 10 | Twin-wall balanced flue elbow 15° |  |
| 16 | USDVC2 10 | Vertical (roof) termination kit, L = 375 mm, incl. ① |  |
| 16 | USSR 10 | Storm collar Ø150 mm |  |
| 17 | USLS 10 | Adjustable roof flashing. Roof pitch 20° - 45° (**), with lead flashing |  |
| 17 | USDH 10 | Roof flashing plate for roof pitch 5° - 30° |  |
| 18 | USDP 10 | Roof flashing for existing chimney or flat roof |  |
| 18 | USDPAL 10 | Roof flashing - Aluminium for existing chimney or flat roof |  |
| 19 | USDHC5 10 | Horizontal (wall) termination kit, L = 475 mm (horizontally adjustable), incl. ② |  |

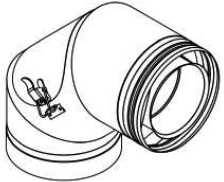
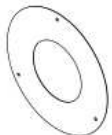
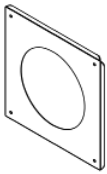
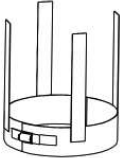

| FIG. NO. | ONTOP ART. / ORDER NO. | DESCRIPTION | |
|----------|------------------------|--|---|
| 20 | USKB 10 | ① : Locking band, quick-fastening |  |
| 21 | USAB 10 | ② : Cover band, screw-fastening |  |
| 23 | USMB 10 | Wall strap, adjustable |  |
| 23 | USEB 10 | Fitting bracket |  |
| 24 | USCP 10 | Set of ceiling finishing plates / Fire stops / Centring plates |  |
| 24 | USDQ 10 | Roof support |  |
| 25 | USSAN 10 | Renovation set |  |
| 25 | USSAN1 10 | Top of renovation set |  |



| FIG. NO. | ONTOP ART. / ORDER NO. | DESCRIPTION | |
|----------|------------------------|---|---|
| 25 | USSAN2 10 | Bottom renovation set |  |
| 28 | USKBS 10 | Locking band, screw-fastening |  |
| | USI 10 | Concentric pipe with inspection panel, L = 250 mm |  |
| 34 | USEM 10 | Concentric pipe with gauging orifice, L = 150 mm |  |
| 35 | USBI 10 | 90° concentric bend with inspection panel |  |
| | USR 10 | Rosette smooth Ø150 mm |  |
| | USMPG 10 | Wall plate large Ø150 mm, ∅300 mm |  |
| | ASAH 10 | Spacer bracket |  |

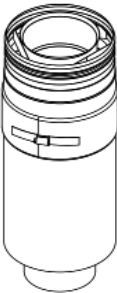
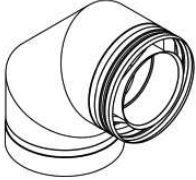

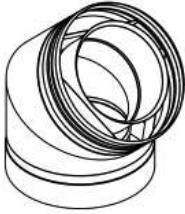
| FIG. NO. | ONTOP ART. / ORDER NO. | DESCRIPTION | |
|----------|------------------------|---|---|
| | USVG 10 13 | Concentric reduction of $\text{Ø}100\text{-}\text{Ø}150\text{ mm} \rightarrow \text{Ø}130\text{-}\text{Ø}200\text{ mm}$ |  |

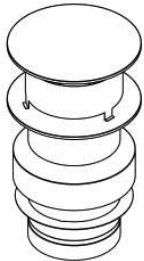
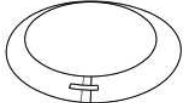
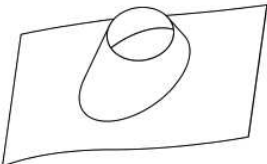
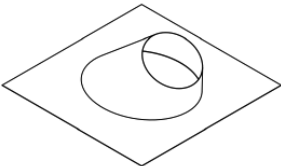

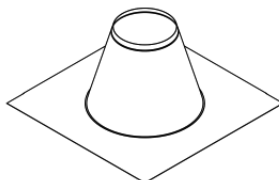
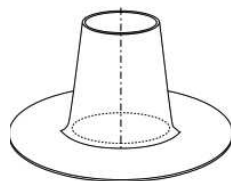
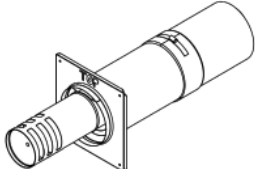

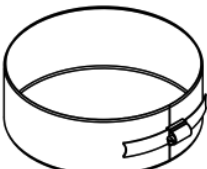
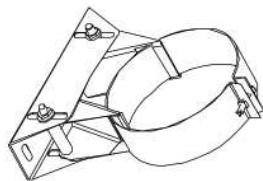
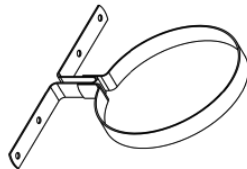
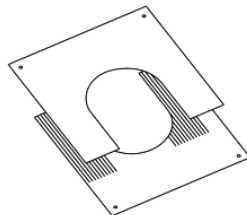
AVAILABLE COMPONENTS FOR THE ONTOP METALOTERM US CONCENTRIC FLUE SYSTEM $\text{Ø}130\text{ mm} - \text{Ø}200\text{ mm}$

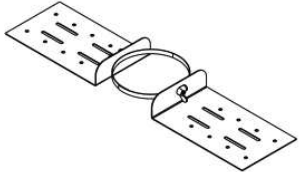
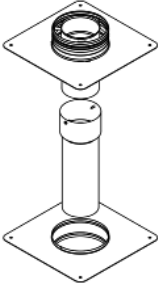
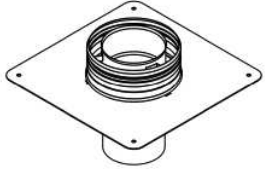
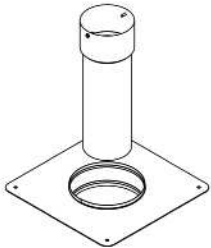
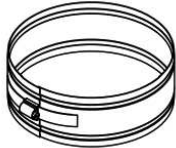
| FIG. NO. | ONTOP ART. / ORDER NO. | DESCRIPTION | |
|----------|------------------------|--|---|
| | USA 13 | Adapter for Bellfires appliances with $\text{Ø}130\text{-}\text{Ø}200\text{ mm}$ concentric connection |  |
| | US 25 13 | Twin-wall balanced flue pipe, L = 250 mm |  |
| 10 | US 50 13 | Twin-wall balanced flue pipe, L = 500 mm | |
| 11 | US 100 13 | Twin-wall balanced flue pipe, L = 1000 mm | |
| 12 | USPP 13 | Telescopic twin-wall balanced flue pipe, L = min. 60 / max. 250 mm |  |
| 14 | USB 90 13 | Twin-wall balanced flue elbow 90° |  |

| FIG. NO. | ONTOP ART. / ORDER NO. | DESCRIPTION | |
|----------|------------------------|--|---|
| 15 | USB 45 13 | Twin-wall balanced flue elbow 45° |  |
| | USB 30 13 | Twin-wall balanced flue elbow 30° |  |
| | USB 15 13 | Twin-wall balanced flue elbow 15° |  |
| 16 | USDVC2 13 | Vertical (roof) termination kit, L = 375 mm, incl. ① |  |
| 16 | USSR 13 | Storm collar Ø150 mm |  |
| 17 | USLS 13 | Adjustable roof flashing. Roof pitch 20° - 45° (**), with lead flashing |  |
| 17 | USDH 13 | Roof flashing plate for roof pitch 5° - 30° |  |

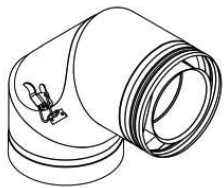
| FIG. NO. | ONTOP ART. / ORDER NO. | DESCRIPTION | |
|----------|------------------------|--|---|
| 18 | USDP 13 | Roof flashing for existing chimney or flat roof |  |
| 18 | USDPAL 13 | Roof flashing - Aluminium for existing chimney or flat roof |  |
| 19 | USDHC4 13 | Horizontal (wall) termination kit, L = 475 mm (horizontally adjustable), incl. ② |  |
| 20 | USKB 13 | ① : Locking band, quick-fastening |  |
| 21 | USAB 13 | ② : Cover band, screw-fastening |  |
| 23 | USMB 13 | Wall strap, adjustable |  |
| 23 | USEB 13 | Fitting bracket |  |
| 24 | USCP 13 | Set of ceiling finishing plates / Fire stops / Centring plates |  |

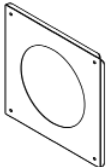
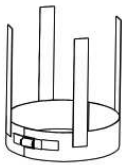
| FIG. NO. | ONTOP ART. / ORDER NO. | DESCRIPTION | |
|----------|------------------------|---|---|
| 24 | USDQ 13 | Roof support |  |
| 25 | USSAN 13 | Renovation set |  |
| 25 | USSAN1 13 | Top of renovation set |  |
| 25 | USSAN2 13 | Bottom renovation set |  |
| 28 | USKBS 13 | Locking band, screw-fastening |  |
| | USI 13 | Concentric pipe with inspection panel, L = 250 mm |  |
| 34 | USEM 13 | Concentric pipe with gauging orifice, L = 150 mm |  |

| FIG. NO. | ONTOP ART. / ORDER NO. | DESCRIPTION | |
|----------|------------------------|---|---|
| 35 | USBI 13 | 90° concentric bend with inspection panel |  |
| | USR 13 | Rosette smooth Ø200 mm |  |
| | USMPG 13 | Wall plate large Ø200 mm, \sphericalangle 350 mm |  |
| | ASAH 13 | Spacer bracket |  |
| | USVG 13 10 | Concentric reduction of Ø130-Ø200 mm → Ø100-Ø150 mm |  |



- The room-sealed gas appliances have been approved in combination with the components of the concentric flue systems listed in this instruction book, according to the European CE norm for gas appliances and may therefore be used **only** with these components.
- The components of the concentric flue system of Bellfires (M&G system), Poujoulat (PGI system) and Ontop (Metaloterm US system) may **not** be used together in one installation.
- Check whether the wall or roof termination kit to be used **exactly** matches one of those listed in this instruction book.

1.6.3 Gas connection

Operation (gas regulating block (and receiver)) **outside** the appliance (in the operating unit):

The gas connection is situated where the operating unit is built in near to the appliance.

Use only gas piping with a minimum diameter of 1/2" and a shut-off valve.

1.6.4 Operating unit

If the appliance is fitted with an operating unit comprising gas control block and receiver, this will be located, once it has been built in, at a **maximum of 50 cm** from the left or right hand side of the appliance.

1.6.5 Convection package connections

When fitting a convection package (= convection casing and convection set (1x or 2x)), consideration should be given to the openings at approximately 1 meter above the appliance for the warm air exiting grids.

1.7 POSITIONING THE APPLIANCE

Important: The fireplace is constructed on a sufficiently solid floor that can bear the weight of the appliance.



Ensure a free space of at least 6 cm between the bottom of the appliance and the floor.

Ensure that the temperature of the floor under and in front of the appliance can never rise above 85°C!

Make use of a temperature protection plate (of nonflammable material) on the floor if necessary.

Take care with a floor made of a flammable material.

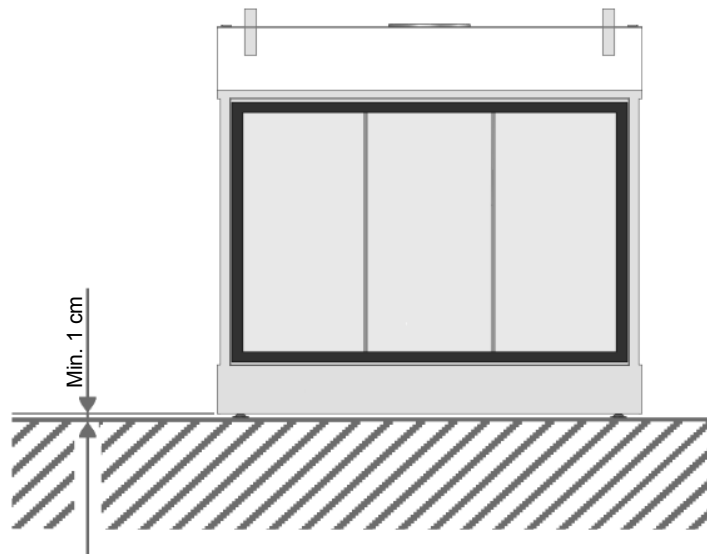

Figure 15: A clearance of at least 6 cm must be maintained between the bottom of the appliance and the floor.

**Never position the appliance directly against the rear wall, but always place a nonflammable insulation plate, at least 12 mm thick, between the appliance and the rear wall, with free space on either side of 2 cm. (Total \pm 5 cm.)
The rear wall must be made of nonflammable material.**

Never use combustible materials during the installation.

Ventilate the fireplace, by allowing vents above and below the fireplace.

During installation of the gas fire, a clearance of 3 mm should be maintained on all sides of the appliance to allow for expansion of the appliance during operation.

Do not insulate the appliance! Only the top and sides may be fitted with a strip of white, loose insulation wool (heat-resistant to 1000°C), width 15 cm max. to protect the wall.

Do not use fibreglass or Rockwool, or any other sort of insulating material. These emit a pungent odour. This is considered extremely unpleasant. They may also cause discolouring of the column.

**Flammable materials, such as curtains, should not be placed in the vicinity of the gas fire.
Minimum safe distance: 100 cm.**

If desired, fit a convection package to the appliance.
(See chapter 1.1)



The appliance can be easily installed using a set of carrying brackets (accessory).
After installing: remove carrying brackets!

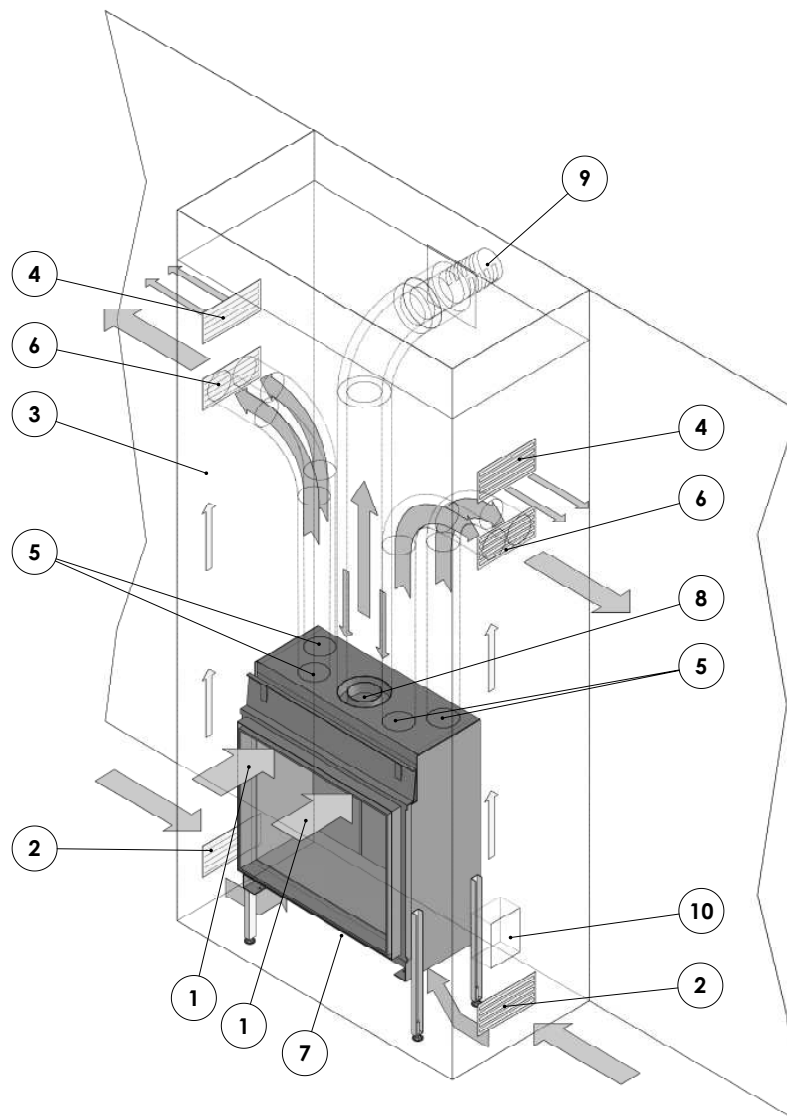
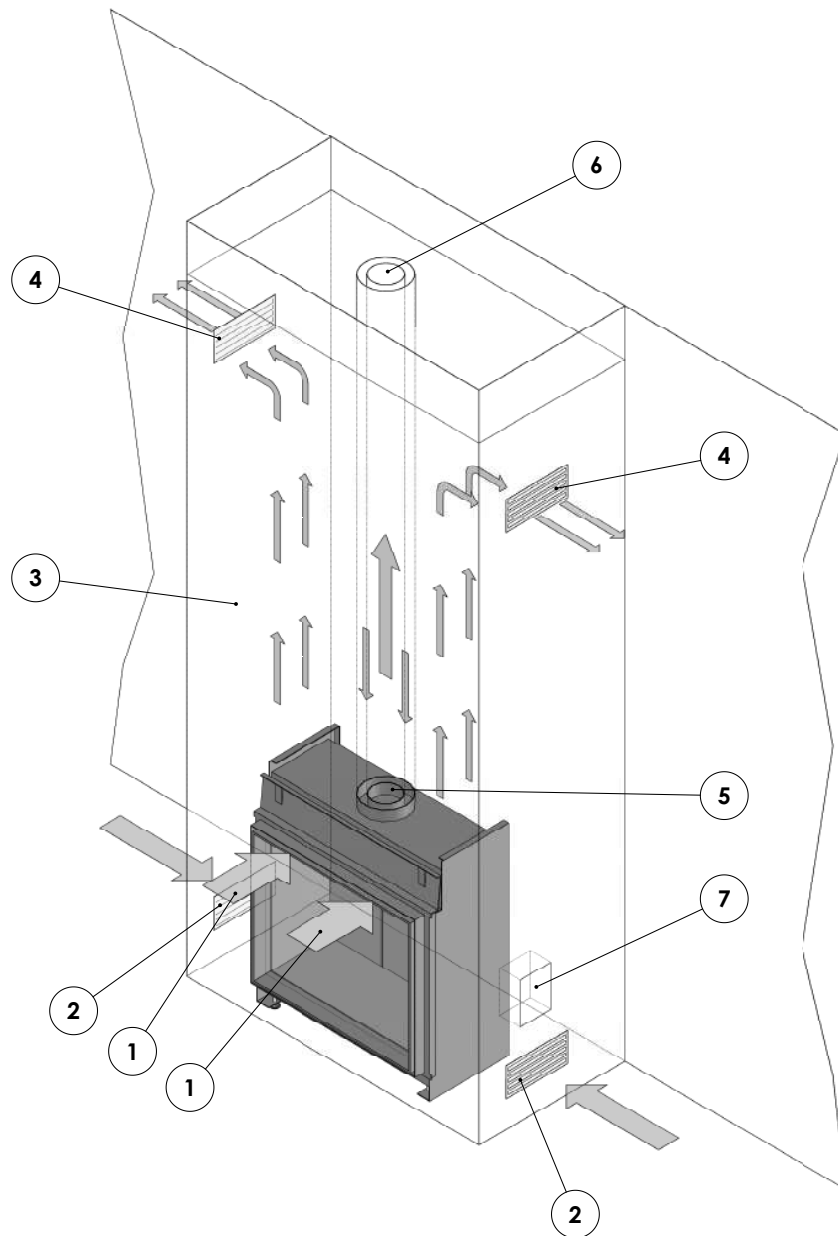

**Figure 16: Appliance installed in ventilated chimney breast
Horizontal outlet of the flue gas exhaust / combustion air
supply via the wall.**

Fitted with the options / accessories:

- convection package (= convection casing and 1x convection set)
- 1x extra convection set
- high adjustable feet

-
- 1 Inlet opening (appliance) convection air
 - 2 Inlet opening (grate) (chimney breast) convection air
 - 3 Natural convection in the chimney breast
 - 4 Outlet opening (grate) (chimney breast) natural convection air
 - 5 Outlet opening (appliance) convection air / connection convection set (2x or 4x)
 - 6 Outlet opening (grill convection set) (chimney breast) convection air (2x or 4x)
 - 7 -
 - 8 Concentric flue connection appliance; Ø130-200 mm for a horizontal wall outlet
 - 9 Horizontal wall outlet
 - 10 Built in operating unit with gas regulating block and receiver



**Figure 17: Appliance installed in ventilated chimney breast
Vertical outlet of the flue gas exhaust / combustion air
supply via the roof.
Fitted without convection package**

- 1 Inlet opening (appliance) convection air
- 2 Inlet opening (grate) (chimney breast) convection air
- 3 Natural convection in the chimney breast
- 4 Outlet opening (grate) (chimney breast) convection air (2x)
- 5 Concentric flue connection appliance; Ø100-150 mm for a vertical roof outlet
- 6 Concentric flue system; Ø100-150 mm for a vertical roof outlet
- 7 Built in operating unit with gas regulating block and receiver

When fitting the appliance, it can be levelled with the adjustable feet.
These adjustable feet can be reached via the openings (4x), after removing the protective covers, in the corners of the floor of the combustion chamber.
The floor of the combustion chamber can be reached after the window and the grill around the burner have been removed (see chapter 4).
Using an Allenkey (no. 5), the appliance can be adjusted to the required height.



Press the 4 protecting covers back into the floor.



- Position 4 protecting covers.



- Protecting cover.



- Adjustable feet seen from the bottom of the appliance.



- Adjust height with Allenkey no. 5.

Position the gas supply pipe such that it can be easily mounted after installation.

Because the control system is outside the appliance, the gas pipe must lead to where the operating unit (built in), the gas regulating block (and the receiver) assembly are fitted.

Move the appliance until it is ± 5 cm from the rear wall and ensure it is level. Place the nonflammable insulation plate (min. 12 mm) between the appliance and rear wall. The appliance may not be installed against a flammable rear wall.

Attach the appliance to the rear wall with 2 wedge bolts. Use the adjustable mounting brackets at the side of the appliance for this.



- 2x Mounting bracket.

1.7.1 Gas connection operating unit

Important:



During gas connection, take care not to twist the gas regulator block. Make sure that both the gas regulator block and the supply pipes are not subjected to stresses.

The appliance is supplied with a built-in operating unit.

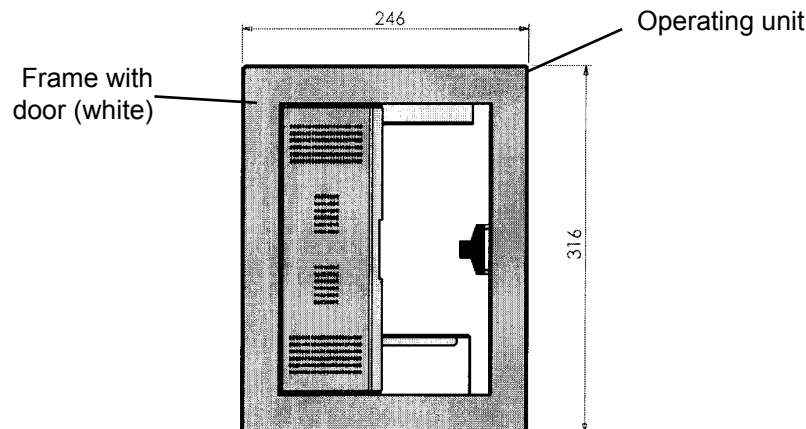

Figure 18: Operating unit

Remove the decorative edging and door of the operating unit.

Fit the separate operating unit, where the gas regulator block and receiver will be placed, on max. 50 cm from the appliance.

The burner, gas regulator block and receiver have been fully factory assembled.

Disconnect the bracket with the gas regulator block and receiver from the appliance. Carefully move the bracket with the gas regulator block, receiver, pipes and cables to the operating unit. Mount the bracket at the bottom of the operating unit.

Important:



Take care that no pipes get damaged and no compression fittings come loose when moving the gas regulator block. Prevent twisting the flexible pipes! Check all compression fittings for leaks afterwards!

Mount the receiver in the top of the operating unit. Check afterwards that all electric connections are properly connected.

General:

Route all piping and cables from the operating unit to the appliance through an easily accessible hollow cavity.

During subsequent installation of the operating unit, protect the gas regulator block and piping against encasement by cement etc.

Important : Cement and chalk can damage the piping and can, in turn, lead to gas leaks.



Disassembly and assembly of pipes and cables:

If necessary for mounting, all pipe compression fittings and cable connectors can be temporarily disassembled. After mounting, carefully reassemble all pipes and cables. Check afterwards all compression fittings for leaks and that all electric connections are properly connected.

Important : Screw the thermocouple connection (and thermocouple interrupter) manually into the gas regulator block. Afterwards, carefully fasten a half turn with a spanner.



Note : Check that the flexible burner pipes are correctly connected! The gas connection of the gas valve “rear burner” must be connected to the “rear burner”! See Chapter 5. Switching over the flexible burner pipes during assembly can lead to an explosive ignition. Prevent this at all costs!

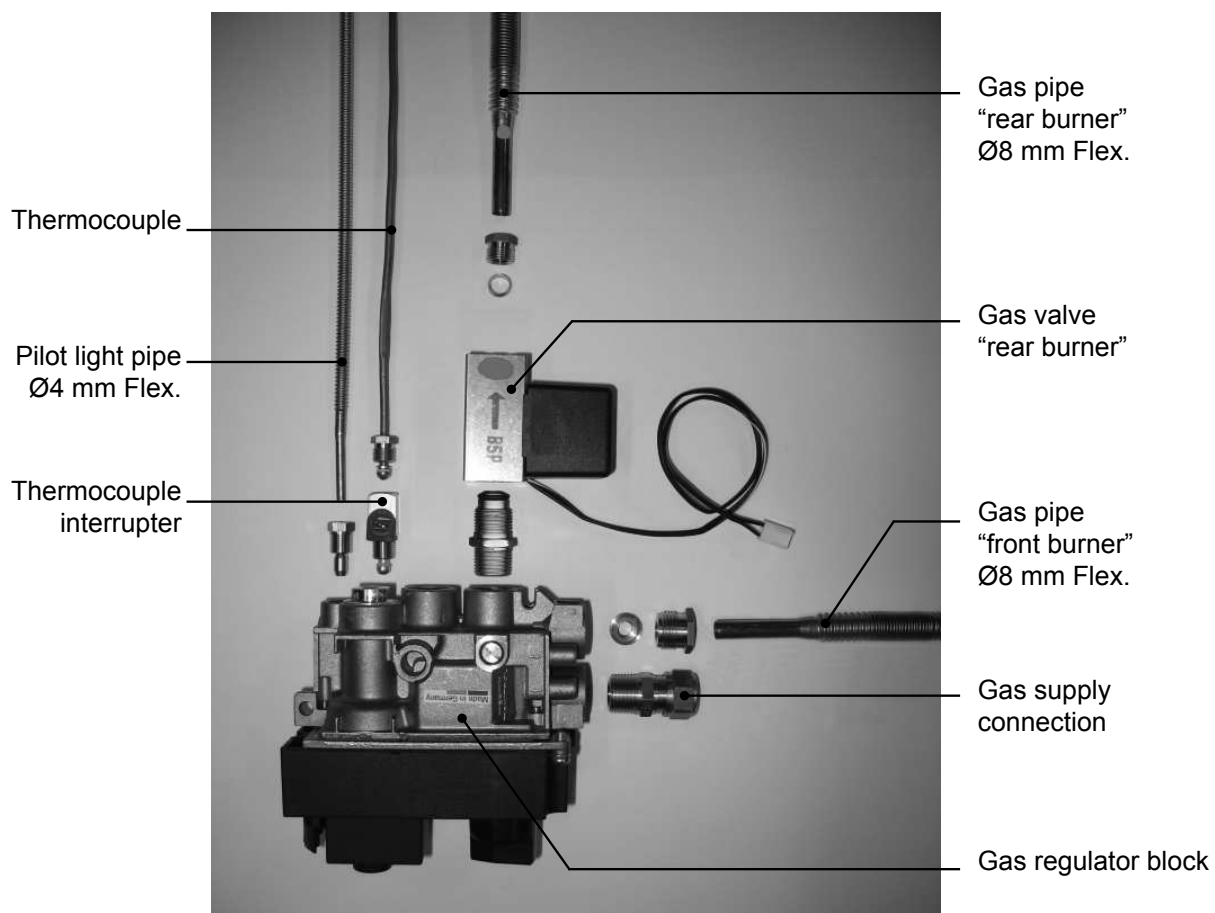

Figure 19: Gas regulator block and gas valve: Gas and thermocouple connections

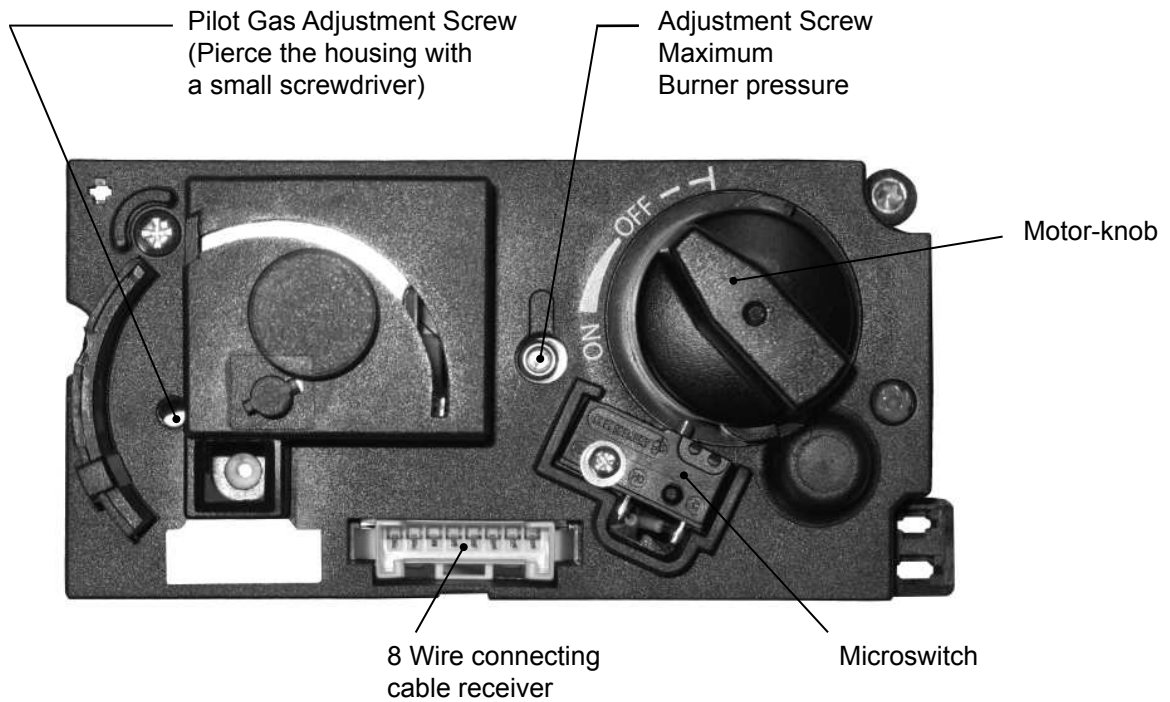

Figure 20: Gas regulator block - Front

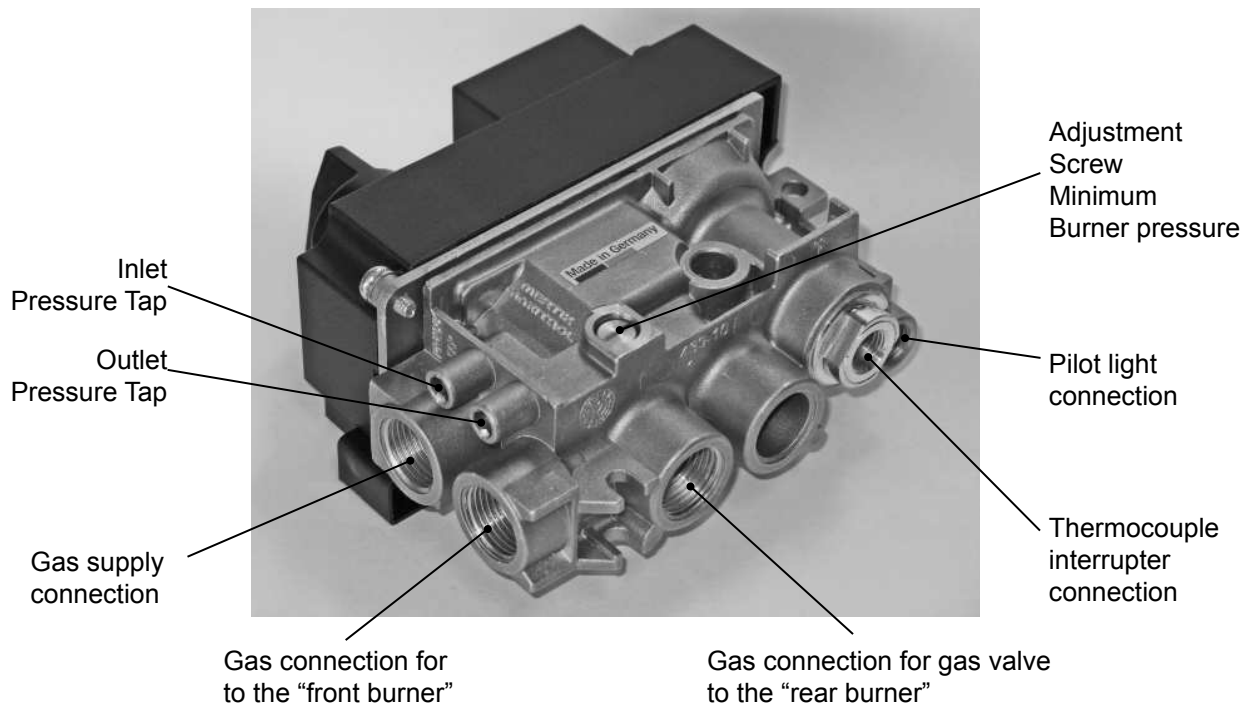

Figure 21: Gas regulator block - Rear

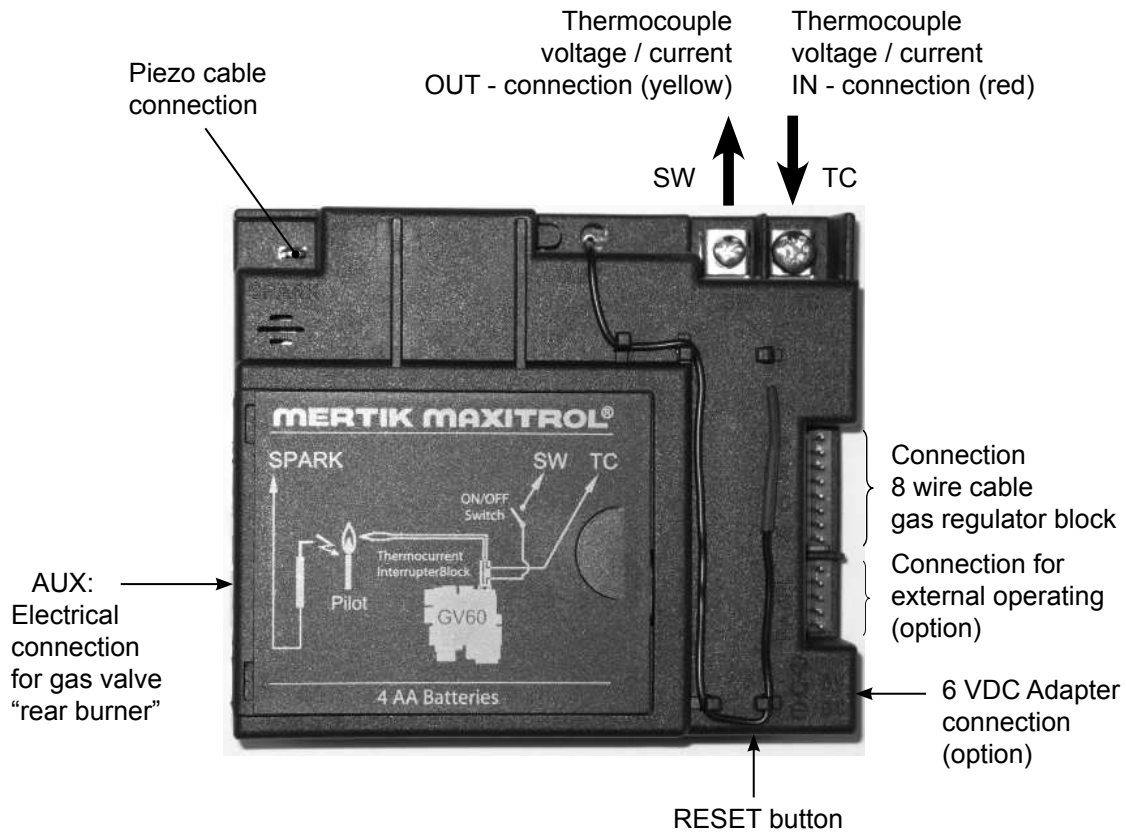

Figure 22: Receiver - Top

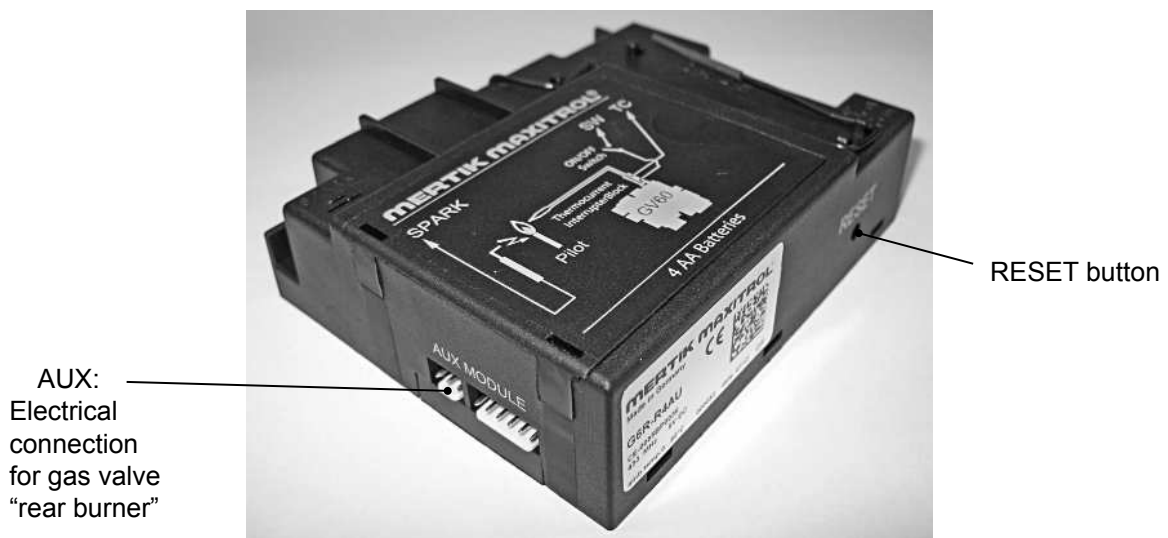

Figure 23: Receiver - AUX connection - RESET button

1.7.2 Connecting the concentric flue

Assemble the concentric flue system according to one of the examples in section 1.6.1, figure 4 to 14 inclusive.

Make sure that all connections are completely gas tight.

1.7.3 Building in the appliance

Remove the front of the casing, if applicable. (See Chapter 4: Dismantling / Assembling of the glass.)

Decide on positions of the vents (grilles above and below the fireplace) and, if applicable, the hot air grids of the convection package.

The brickwork must be built up around the hearth. In connection with the hearth expanding during burning: there must be at least 3 mm clearance on either side of the appliance. Do not build up the brickwork farther than the angle irons/brackets (keep in mind the thickness of any plastering!).



Do not use masking tape on the appliance when installing and plastering.

Tape can damage the finish of the hearth.

Connect up the convection package, if applicable.

The optional mantle iron is intended for supporting the brickwork above the hearth. The mantle iron must rest on the brickwork on both sides so that upward building is possible. The brickwork therefore must not rest on the fireplace; there must be approx. 3 mm clearance in connection with the weight.

If using other materials, such as stone or heat-resistant plating, you should follow the supplier's instructions.

Once the fireplace has been finished, you can now, fit the frame with the small door to the operating unit.

After installation in a new fireplace and/or applying new cement work, the appliance cannot be used for at least four weeks.

1.7.4 Checking the gas connection

After connection of the gas supply, check that all connections are completely gas tight using soapy water or a leak tester.

1.7.5 Positioning the ceramic log set or marble pebbles

The appliance can be supplied with:

- Ceramic log set + embers
- Marble pebbles white (small, white marble stones)
- Marble pebbles grey (small, grey marble stones)

Important:



- **Carefully place the chips of wood/embers/vermiculite granules/ log set or marble pebbles, on and around the main burner according to the directions in this chapter.**
- **Do not place any chips of wood/embers/vermiculite granules/ log set or marble pebbles against the pilot light burner. For that reason, the main burner has a protective pilot-light cowl. Never remove this cowl! Make sure that the pilot flame can burn at all times freely over the main burner. Only in this way is proper ignition of the main burner ensured. Ignoring these directions could lead to a dangerous situation.**
- **Make sure that all burner orifices remains free at all times!**
- **The burner bed (with chips of wood/embers/vermiculite granules) and the positioning of the logs or marble pebbles must not be changed.**
- **Only use those items supplied! These been rigorously checked and the quantities adapted to the appliance.**
- **Replacement parts, including the ceramic mat are available from your dealer.**
- **Fitting may only be carried out by a qualified person.**

Remove the glass according to the instructions in chapter 4; DISMANTLING / ASSEMBLING OF THE GLASS.

1.7.5.1 Ceramic log set + chips of wood + embers + vermiculite granules

- 1 Place the ceramic mat on the burner in such a way that the holes in the mat are in line with the burner openings.
- 2 Remove the embers carefully from their packaging and spread them evenly over the burner mat and the grate around the burner.
- 3 Distribute the vermiculite granules (50 gram) evenly over the burner.

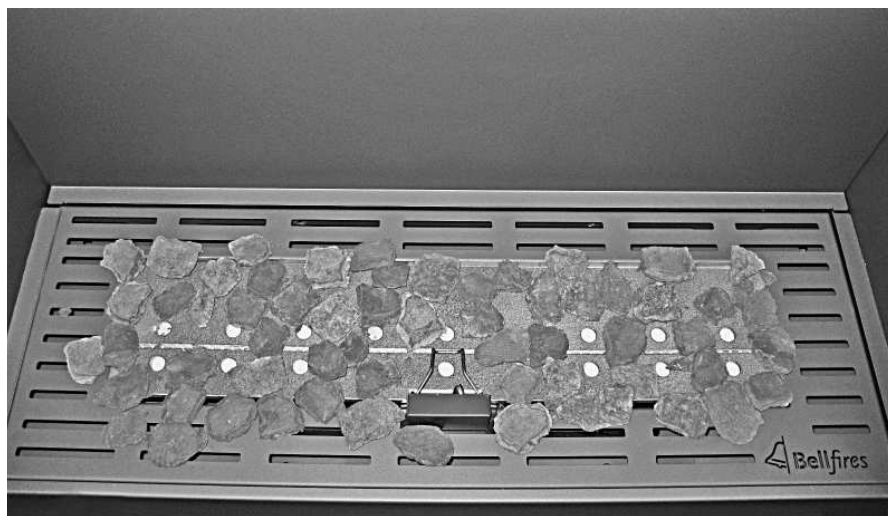

Note ! :



- **Small embers and their residue should not be scattered on the burner. This can cause a blockage on the burner orifices.**
- **Embers and vermiculite granules must not be placed next to the pilot light burner.**
- **Important: make sure that all burner openings remain free !! Burner orifices, which are not open, could lead to a dangerous situation.**

4 Place the logs on the burner:

| <u>Appliance</u> | <u>Natural gas-burner</u> see figure: | <u>Propane / Butane-burner</u> see figure: |
|--------------------|--|---|
| York Large 3 CF/LF | 24 | 25 |

Keep the burner orifices unblocked !!!

5 Place the chips of wood around the burner.

Logs:



Log no 1



Log no 2



Log no 3



Log no 4



Log no 5



Log no 6



Log no 7



Log no 8

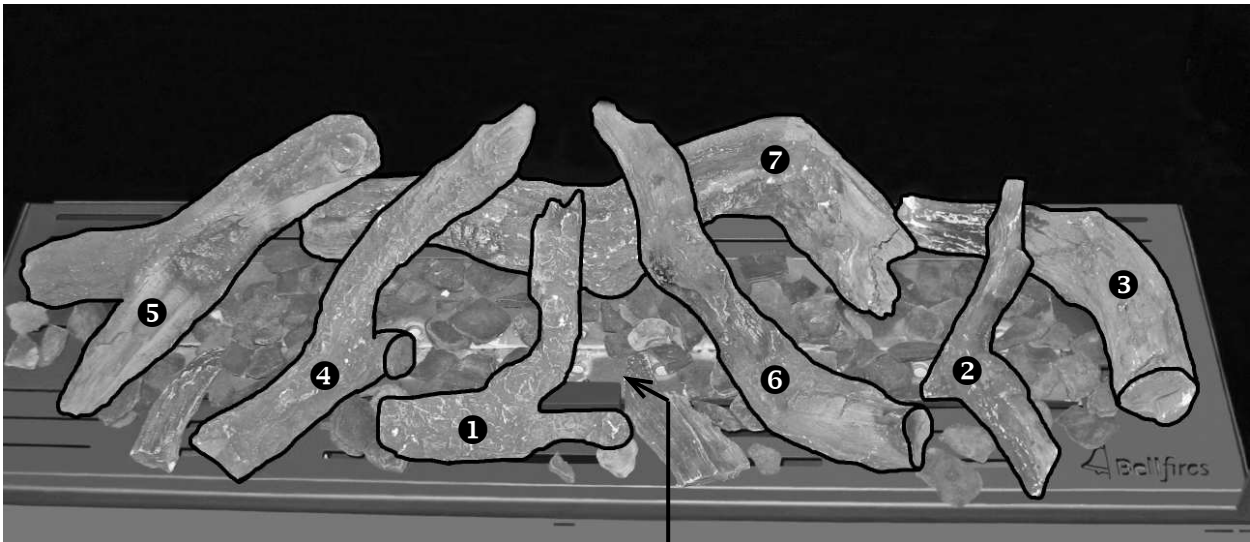

Embers must not be placed next to the pilot light burner

Keep the burner orifices unblocked!

**Figure 24: Log set York Large 3 CF/LF
Position natural gas burner**

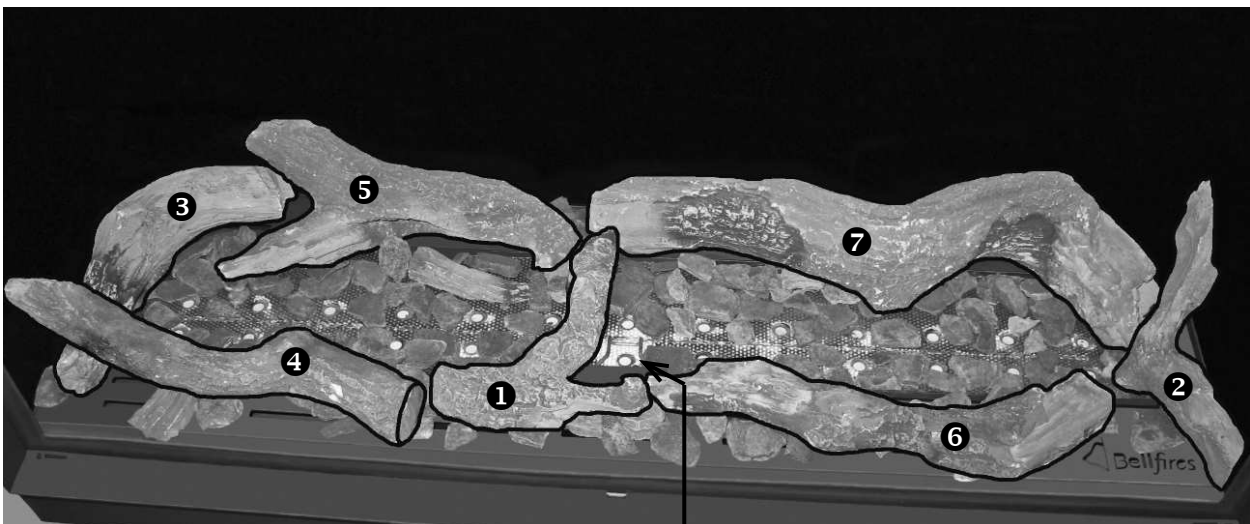

Embers must not be placed next to the pilot light burner

Keep the burner orifices unblocked!

**Figure 25: Log set York Large 3 CF/LF
Position propane/butane burner**

1.7.5.2 Marble pebbles

- 1 Place the ceramic mat on the burner in such a way that the holes in the mat are in line with the burner openings.
- 2 Spread the pebbles over the whole burner bed (burner and grid around the burner). Make sure that the pilot light remains free.

York Large 3 CF/LF : see figure 27

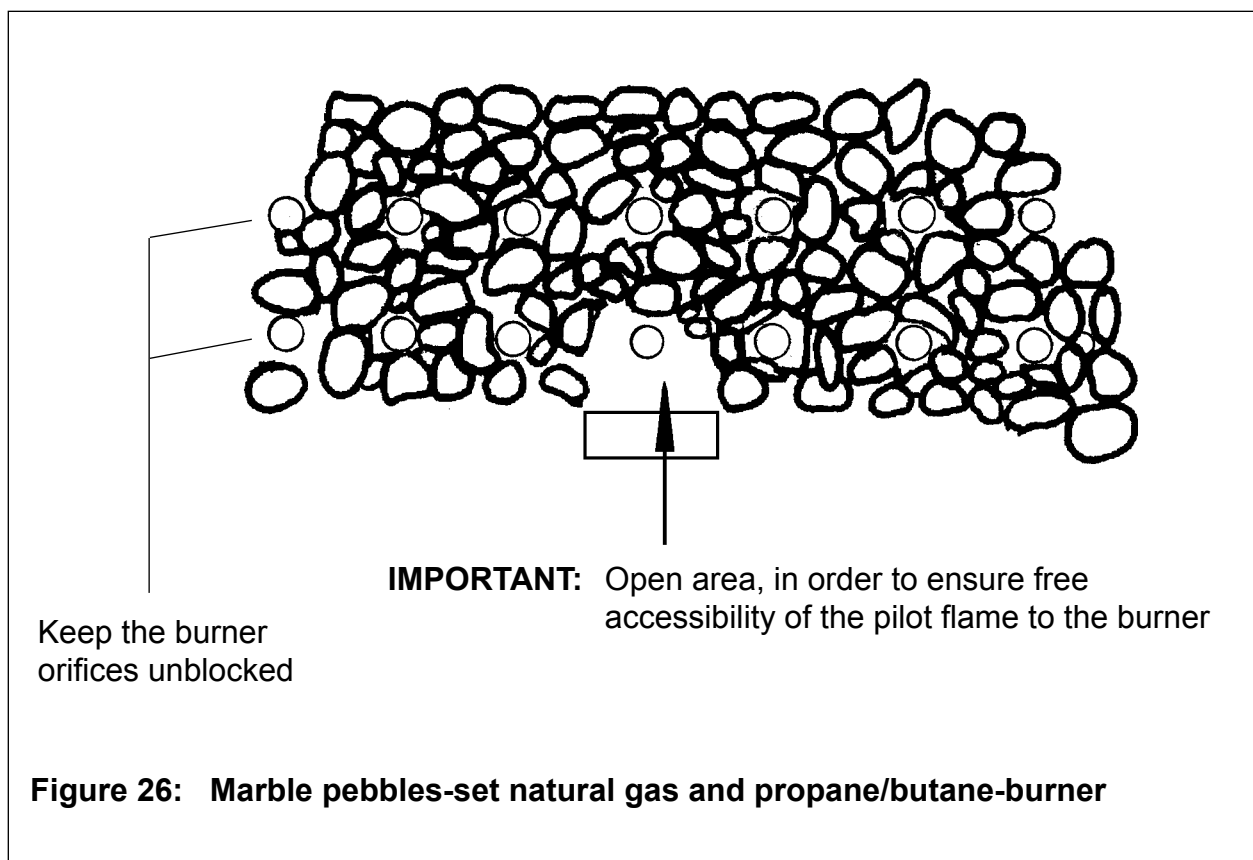

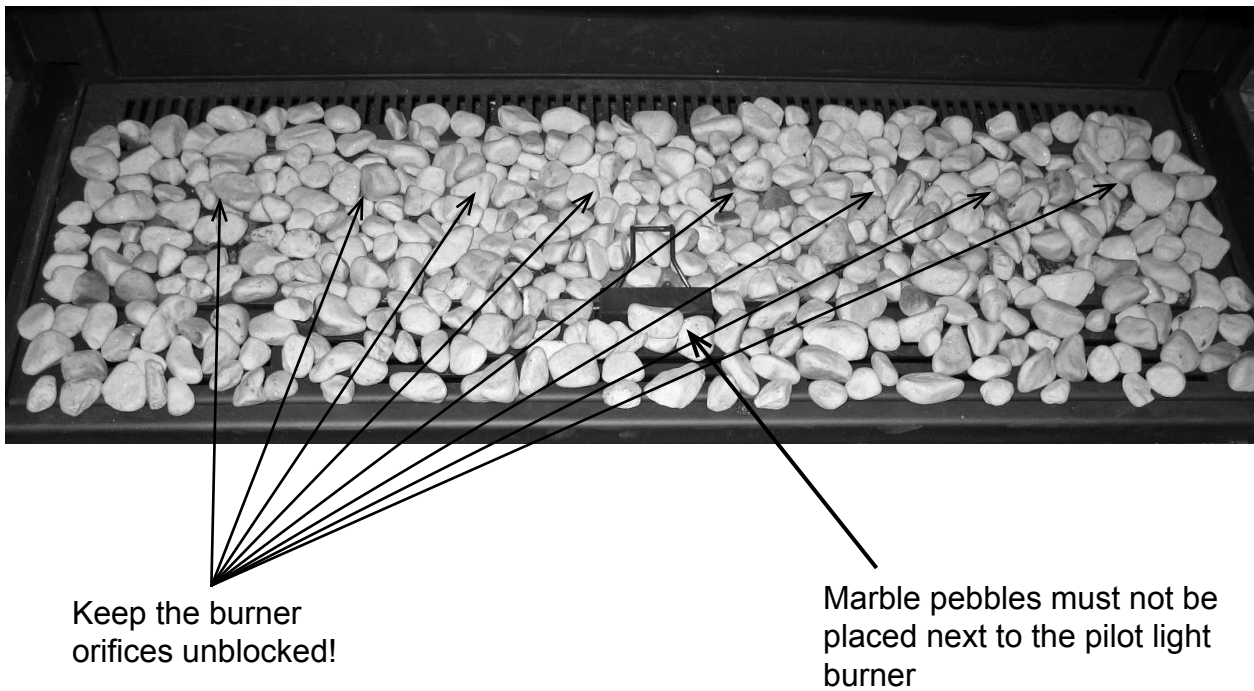

Keep the burner orifices unblocked!

**Figure 27: Marble pebbles York Large 3 CF/LF
Position natural gas and propane/butane burner**

- Important:**
- **Do not place any marble pebbles in front of the pilot light. Make sure that the pilot light can burn freely over the main burner.**
 - **Keep the burner orifices unblocked.**



Only this way a proper ignition of the main burner is ensured.

Once the logs / marble pebbles have been positioned, replace the glass in the appliance, following the instructions in chapter 4: DISMANTLING / ASSEMBLING OF THE GLASS.

1.7.6 Mounting flue gas restriction plate

Depending on the length and shape of the concentric flue system and the chimney construction, you should, if indicated, fit a restriction plate with a certain width (B) into the ceiling of the combustion chamber.

To do this, see the set-up options as listed in figure 4 through 14.

Important:



Ensure that the correct flue gas restriction plate is mounted. Use of the correct flue gas restriction plate will provide optimum efficiency, flame effect and combustion. Mounting an incorrect flue gas restriction plate can result in damage to the gas fire.

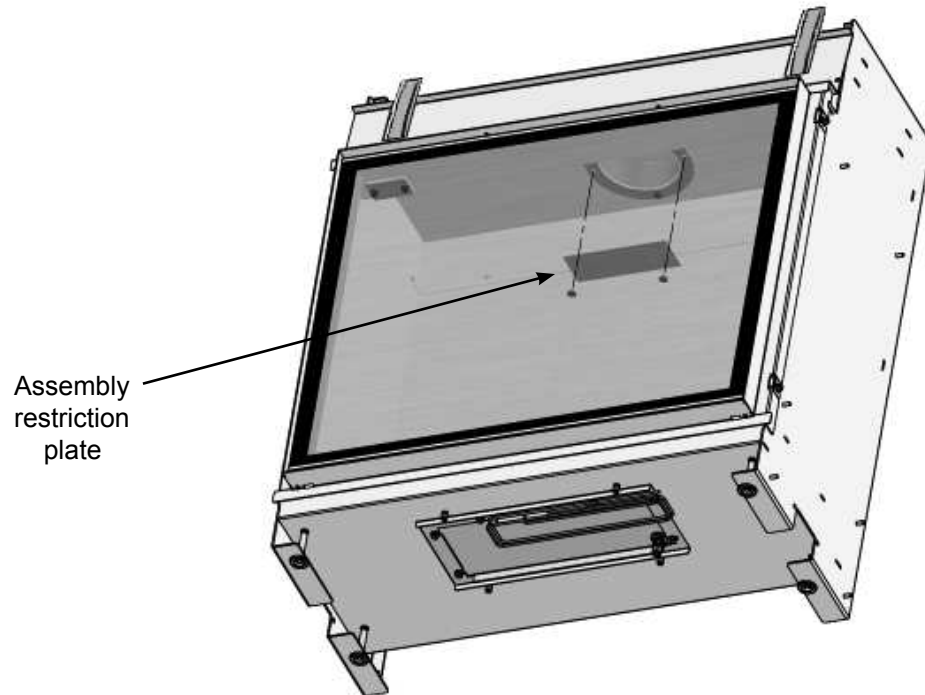
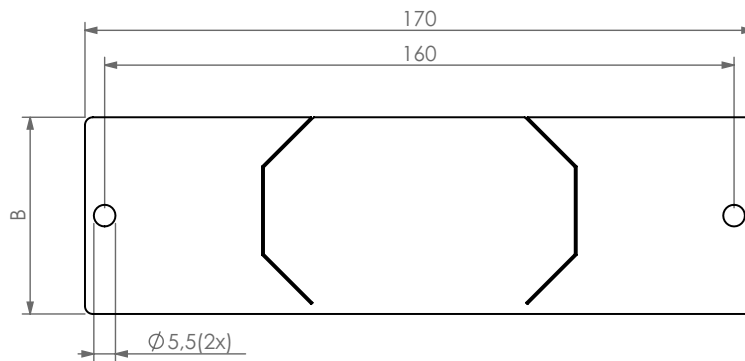

Figure 28: Positioning restriction plate

The following restriction plates are supplied:



| | Concentric flue connection appliance | |
|--------------------|---|--|
| Restriction plate: | [Ø130 - 200 mm] Horizontal wall outlet | [Ø100 - 150 mm] Roof-mounted outlet |
| Width: | - | B = 30 mm |
| Width: | B = 40 mm | B = 40 mm |
| Width: | B = 50 mm | B = 50 mm |
| Width: | B = 65 mm | B = 65 mm |
| Width: | B = 80 mm | - |

1.7.7 Checking the appliance following installation

After installation, visually check the gas flame. When the fire is ignited, the flames should be short and blue/yellow in colour. These flames should gradually increase in height and become more yellow. When all flames are yellow, the gas fire has reached the correct temperature.

THE GAS FIRE IS NOW READY FOR USE

2 MAINTENANCE

2.1 ANNUAL MAINTENANCE



It is **essential** that the appliance, the complete concentric flue system (where possible) and the outlet are cleaned and inspected **annually** by a recognised fitter/gas specialist. The safe operation of the appliance will thus remain guaranteed.

Maintenance consists of the following:

- Remove first the embers, vermiculite granules, logs set or pebbles from the main burner and carefully clean these with a soft brush.
- Clean and inspect (visually) the main burner, pilot light, combustion chamber, flue system and combustion air intake. Dust can be removed using a vacuum cleaner.
- Clean the glass on the inside of the appliance with glass spray or ceramic hob cleaner. This also applies to the black mirror side panels, if the appliance is fitted with these.
- After cleaning;
Carefully replace the embers, vermiculite granules, logs set or pebbles on and around the main burner according to the installation directions in this instruction booklet.
Do not place any embers, vermiculite granules, logs or pebbles against the pilot light burner. Make sure that the pilot flame can burn at all times freely over the main burner. Only in this way is proper ignition of the main burner ensured. Ignoring these directions could lead to a dangerous situation.
- Check the gas supply, flue system, and combustion air supply route for leaks.
- Check the correct operation of the gas regulating block, thermocouple circuit and the ignition of the main burner.
- Check the gas inlet-pressure (both when the appliance is off and when it burns at maximum) and the burner pressure.
- Check the complete concentric flue system including the outlet construction. A camera can be used to inspect the whole length of the flue gas outlet and the combustion air intake.
Also check that all connections are secure.

3 FAULTS

3.1 POSSIBLE REASONS

Possible reasons for the gas fire going out are:

- The concentric flue system is not installed according to one of the methods detailed in Paragraph 1.6.
- An incorrect “flue gas restriction plate” is fitted.
- The pilot light extinguishes if fumes are not exhausted or are insufficiently exhausted.
- The pilot light is either dirty or defective.
- Insufficient gas pressure.
- (Internal) leak of the concentric flue system.
- Thermocouple voltage is too low. This is usually caused by insufficient heating of the thermocouple by the pilot light.
- Dirty electrical contacts in the thermo-electrical system; for example, the thermocouple connection.
- Batteries in receiver or remote control are flat.

3.2 SAFETY MEASURES IN THE APPLIANCE

3.2.1 Thermo-electric pilot light shut off

The appliance is protected by means of a thermo-electric pilot light shut off in the event of a gas escape from the main burner.

3.2.2 Over pressure safety system

The appliance is fitted with a patented safety system, whereby the door will extract any over-pressure that arises in a controlled way. In this, a spring system briefly causes the door to hinge forward a few centimetres. A loud noise can occur.

A safety strip limits the maximum degree to which the door can be tilted.

If an over-pressure situation occurs, the appliance should be thoroughly checked by the installer.

4 DISMANTLING / ASSEMBLING OF THE GLASS

4.1 YORK LARGE 3 FLOATING FRAME

Dismantling of the glass:



- York Large 3
Floating Frame



- Use the hook supplied (see photo) for opening the frame and the glass.

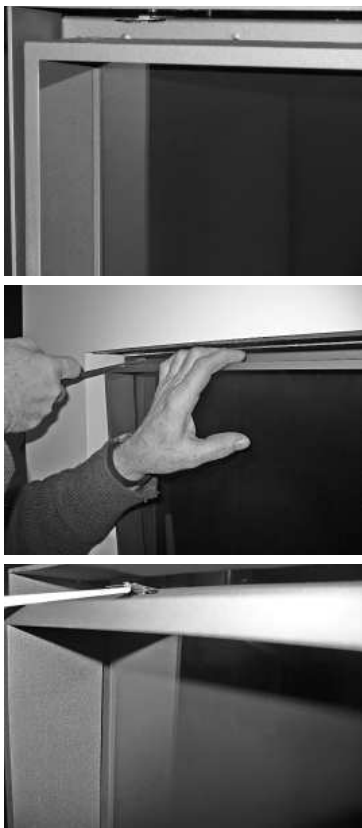

- With the hook, pull the thin, metal spring strips on the top left and right from the studs on the frame.

Note ! :



When loosening the frame and after it has been loosened, support it with your hand to prevent it falling forward !



stud (right)

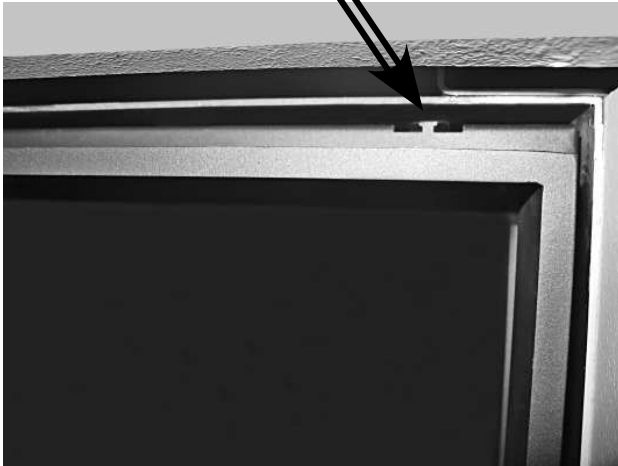

- Detail of the stud (right).



- Place paperboard on the chimney breast, under the frame. This helps prevent damage.



- Dismantle the safety strip from the frame.



- Carefully tilt the frame and the window forwards.

Note ! : Frame and window are two separate parts !

- Take hold of the frame and the glass clamped together and pull these upwards.



- Frame and glass are now removed from the appliance.

Assembling of the glass:

The assembly of the glass takes place in reverse order.

Important:

- Check whether the frame is properly positioned underneath in the 2 holes of the front.
- Check whether the frame is placed in the middle of the front.
- Check whether the safety strip is securely fastened to the top of the frame (middle).
- The glass (frame) must fit tightly all round to the edge of the combustion chamber.
- Check that the spring strips, on the top, remain in their proper place.

4.2 YORK LARGE 3 HIDDEN DOOR

Dismantling of the glass:



- York Large 3 Hidden Door.

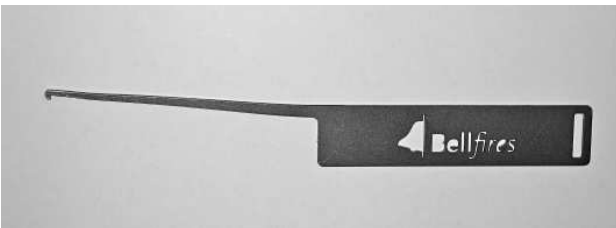

- Use the hook supplied for opening the frame (including glass).



- Use the hook to pull the frame at the top forward and hold the frame firmly.

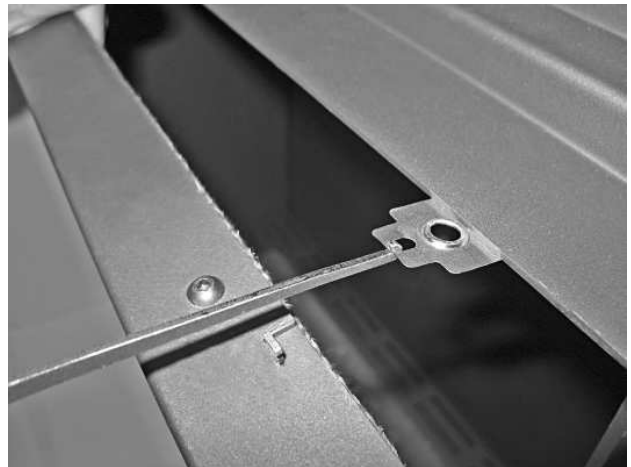

- With the hook, pull the thin, metal spring strips on the top left and right from the studs on the frame.



- Dismantle the safety strip from the frame.

Note ! :



When loosening the frame and after it has been loosened, support it with your hand to prevent it falling forward !



- Carefully tilt the frame and the glass forwards at the top.
Prevent damage by laying paperboard on the chimney breast, under the frame.
Pull the frame upwards and remove it from the appliance.

Assembling of the glass:

The assembly of the glass takes place in reverse order.

Important:

- Check whether the frame is properly positioned underneath in the 2 holes of the front.
- Check whether the frame is placed in the middle of the front.
- Check whether the safety strip is securely fastened to the top of the frame.
- The glass (frame) must fit tightly all round to the edge of the combustion chamber.
- Check that the spring strips, on the top, remain in their proper place.

5 DIAGRAM ELECTRICITY AND GAS

Double burner: ● : Perforation pattern "Centre Fire" double burner.
 ● + ● : Perforation pattern "Line Fire" double burner.

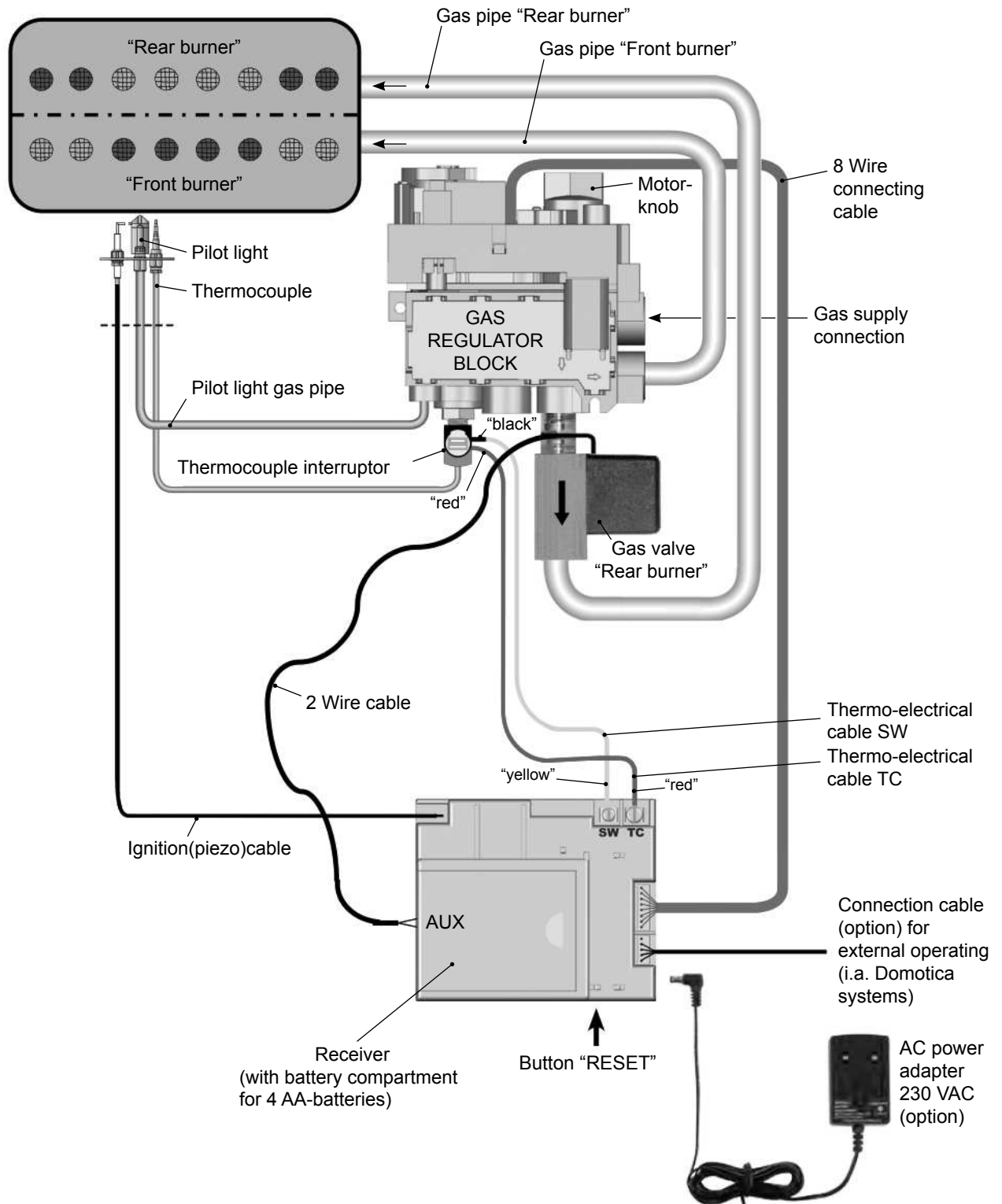

6 DIMENSIONS

6.1 YORK LARGE 3

6.1.1 YORK LARGE 3 - Hidden Door

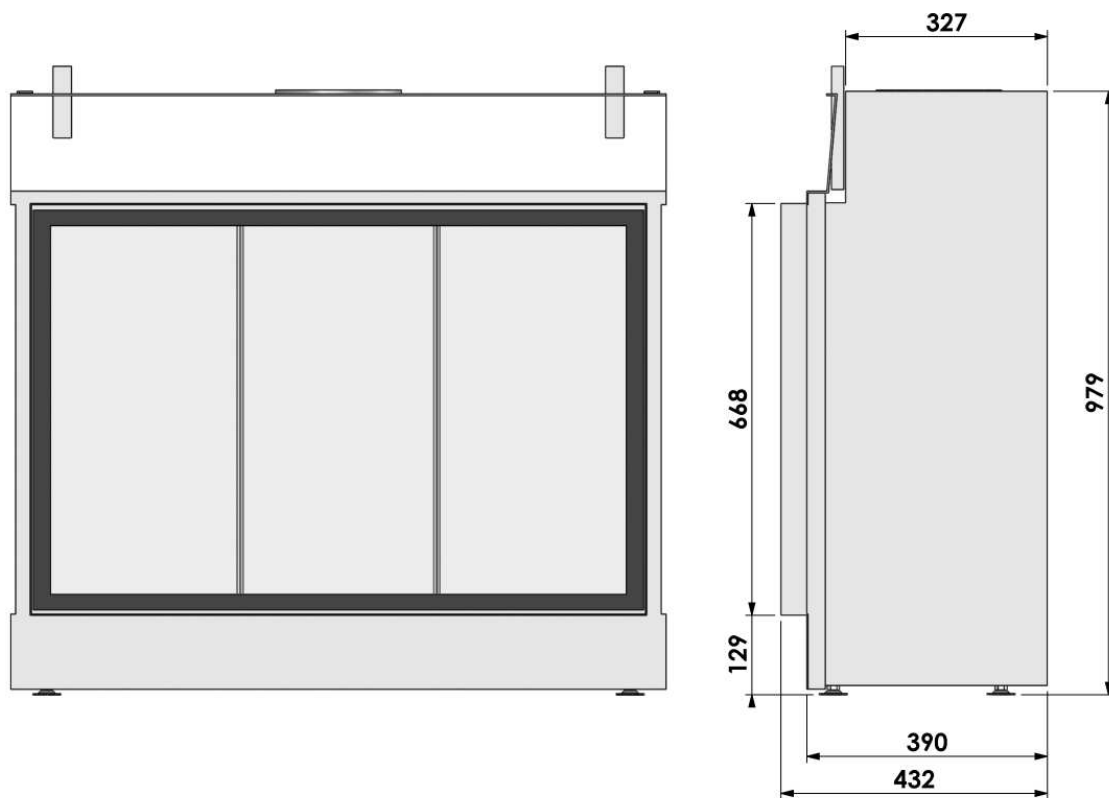
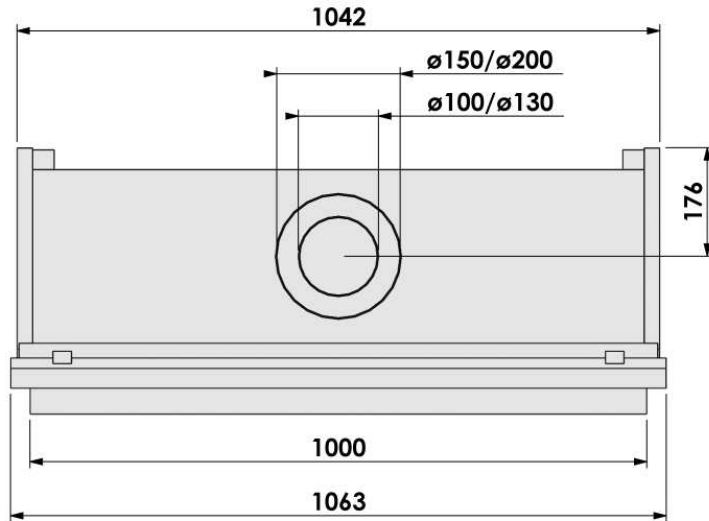

6.1.2 YORK LARGE 3 - Floating Frame

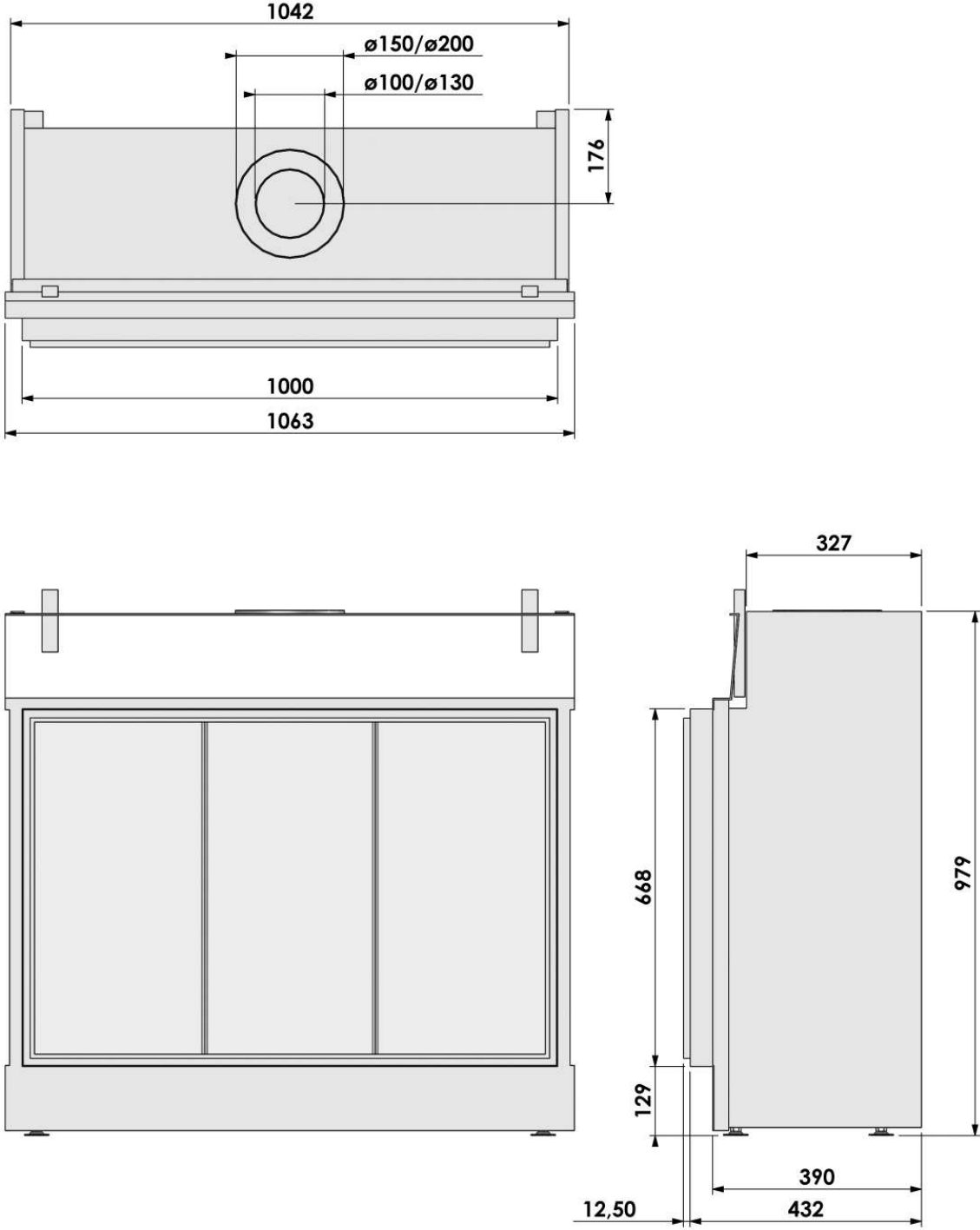

6.2 YORK LARGE 3 Fitted with the options: - Convection casing
- High adjustable feet

6.2.1 YORK LARGE 3 - Hidden Door

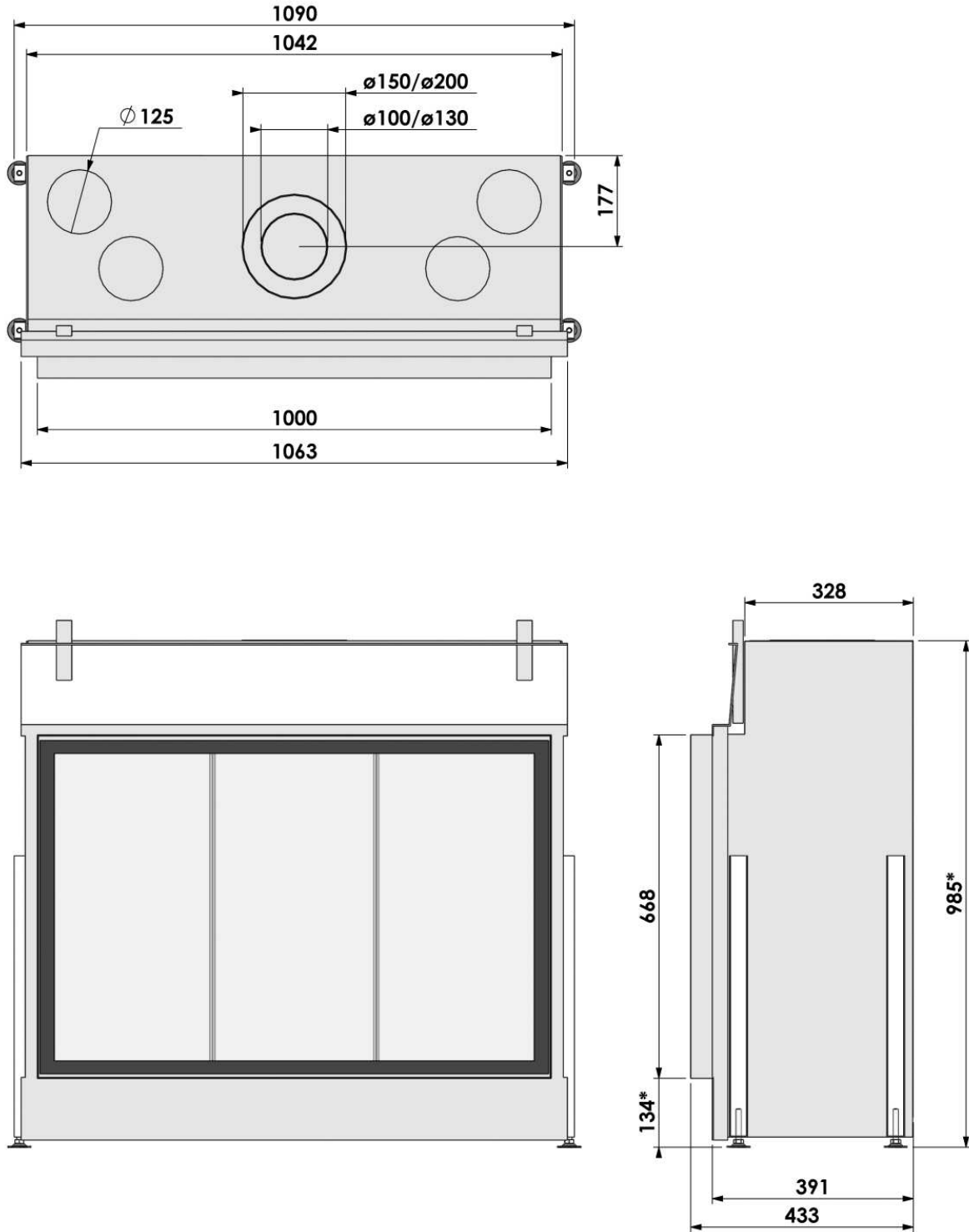

* With the high adjustable feet (option), the appliance can be installed till 350 mm above the floor.

6.2.2 YORK LARGE 3 - Floating Frame

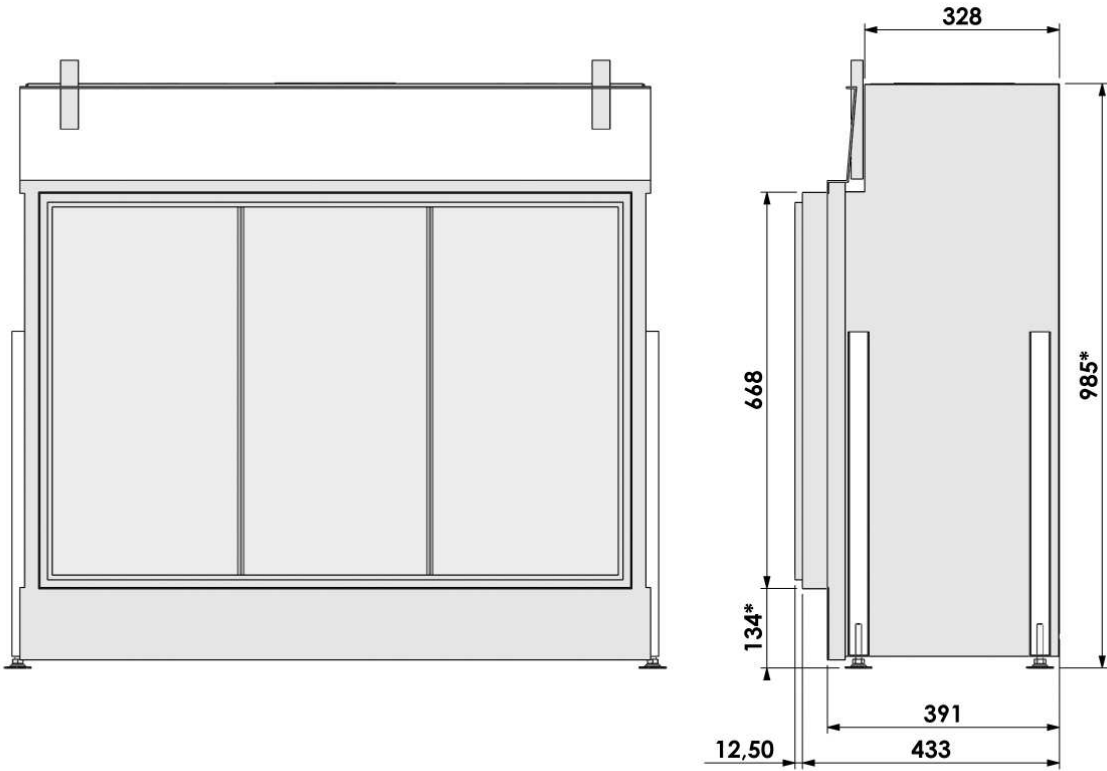
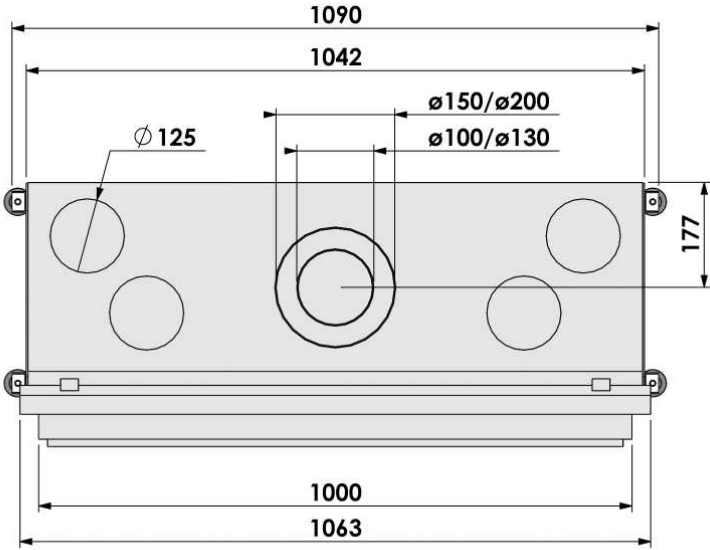

* With the high adjustable feet (option), the appliance can be installed till 350 mm above the floor.

6.3 YORK LARGE 3 Hidden Door Plus (+)

6.3.1 YORK LARGE 3 - Hidden Door Plus (+) 7 cm Frame

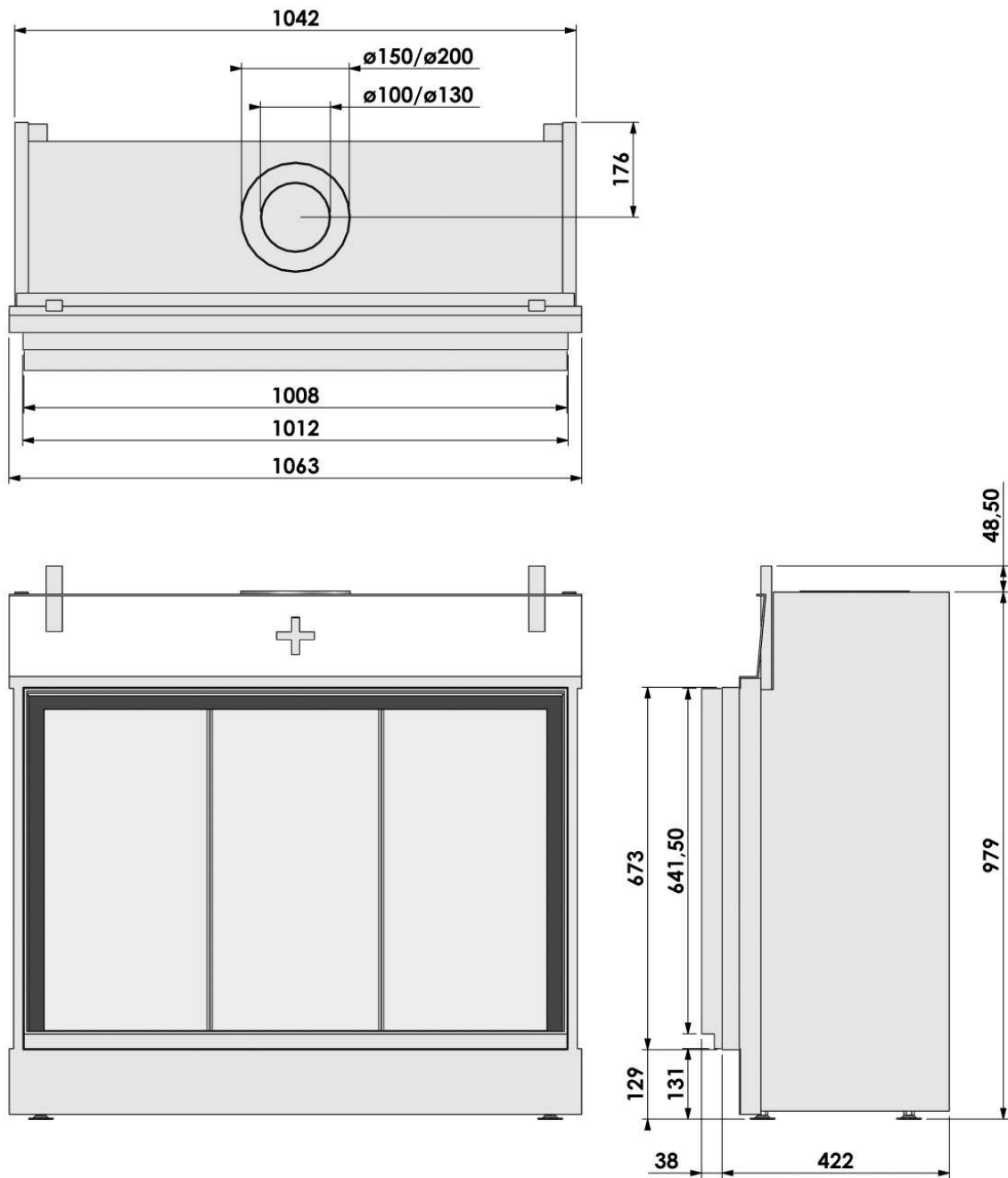

* With the high adjustable feet (option), the appliance can be installed till 350 mm above the floor.

6.3.2 YORK LARGE 3 - Hidden Door Plus (+) 10 cm Frame

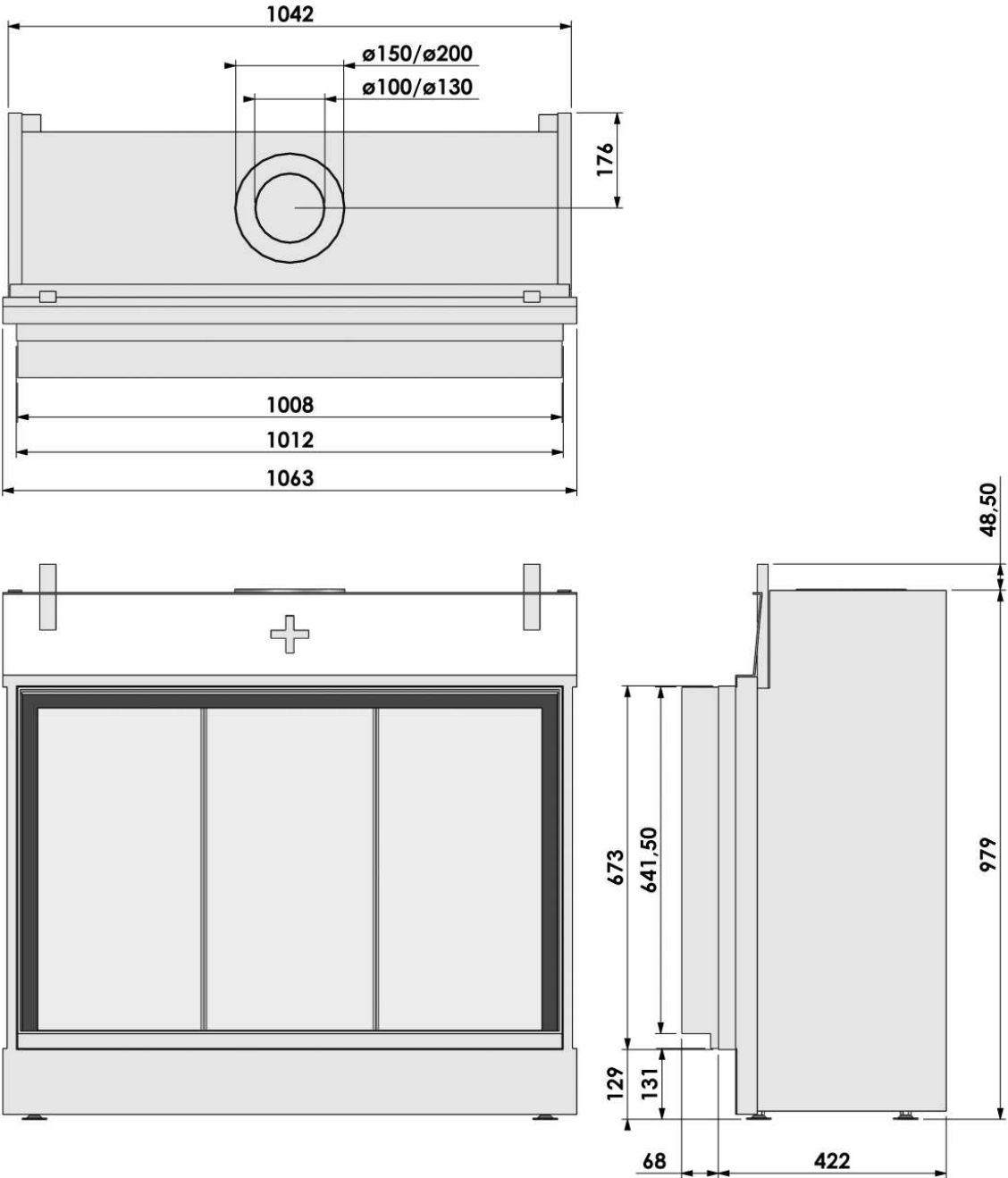

* With the high adjustable feet (option), the appliance can be installed till 350 mm above the floor.

6.3.3 YORK LARGE 3

Hidden Door Plus (+) 10 cm Frame & Decorative Stone

Fitted with the options: - Convection top plate
- High adjustable feet

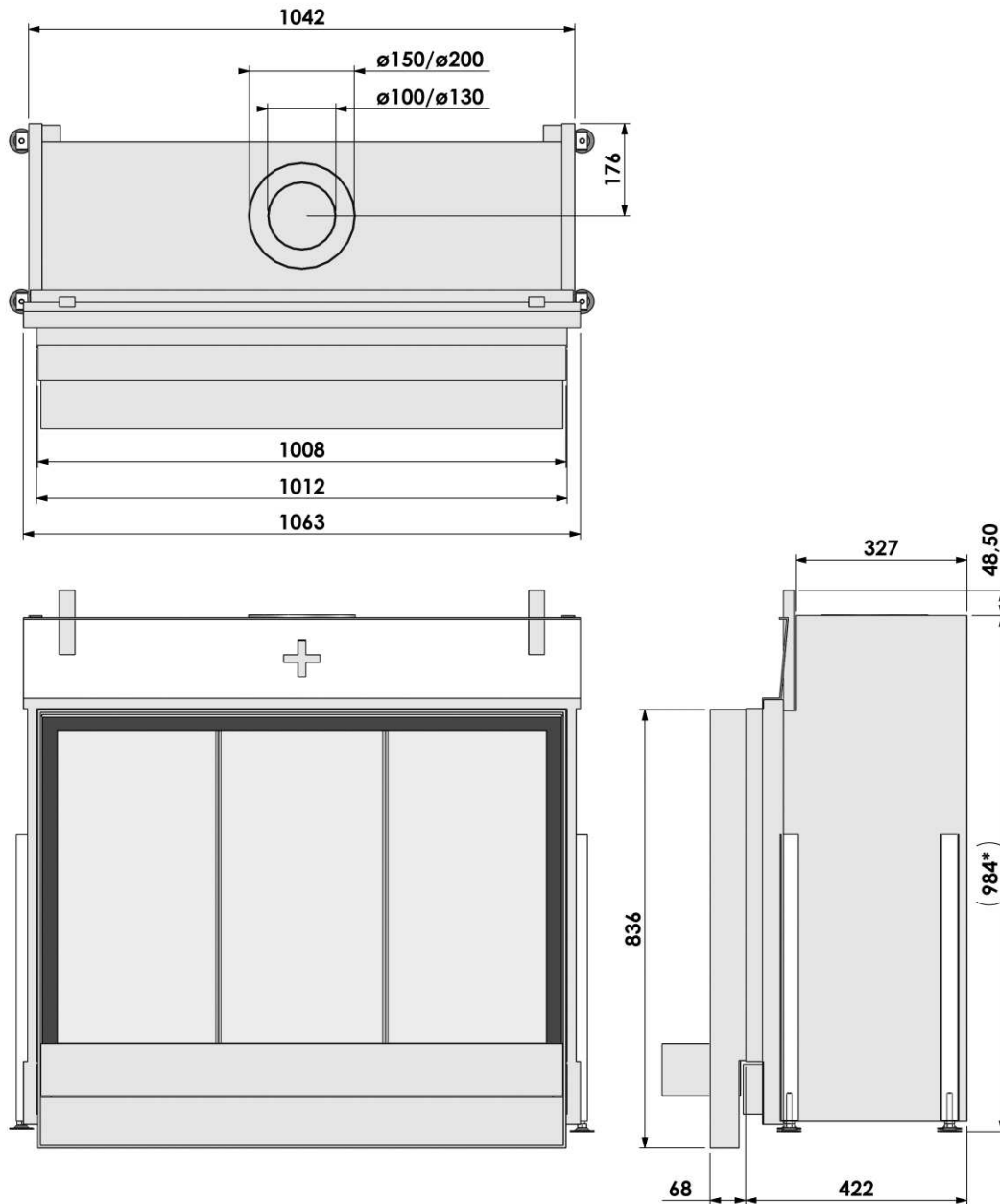

* With the high adjustable feet (option), the appliance can be installed till 350 mm above the floor.



With this model the remote control receiver and the gas regulating block are located in the fire and can be accessed via the metal cover, under the stone. The gas fire does not have a separate operating unit !!

OPERATING UNIT

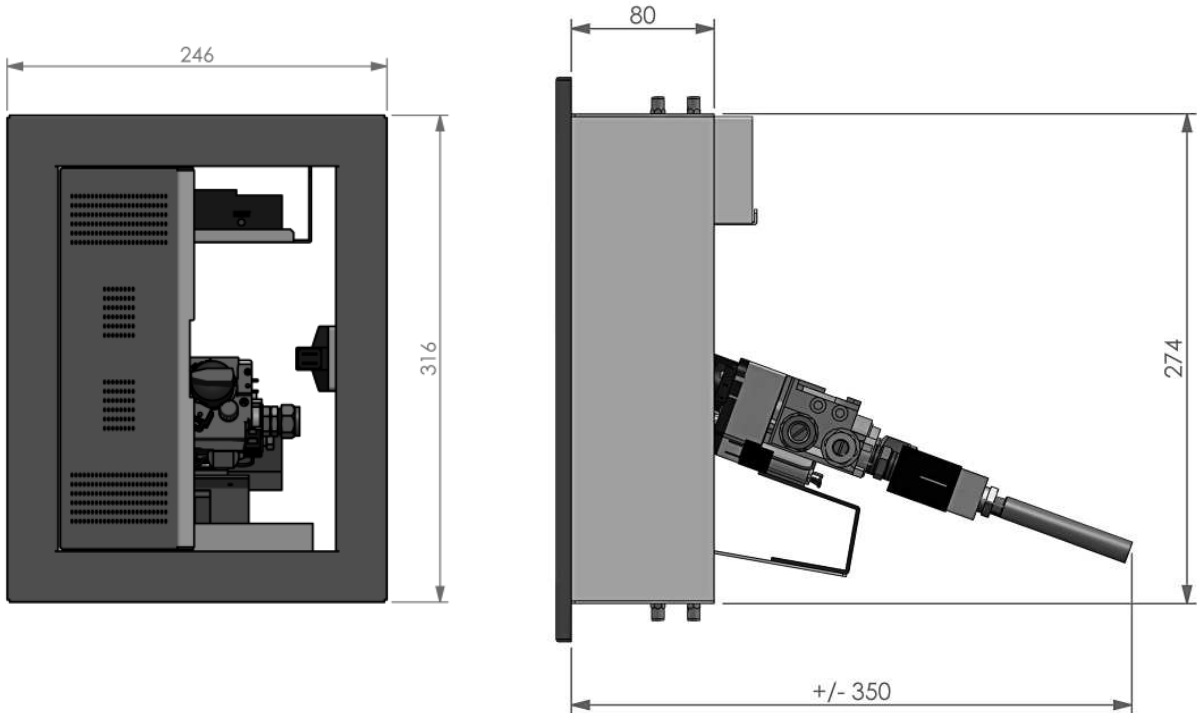

7 TECHNICAL DETAILS/REGULATIONS

National installation regulations:

- UK : • **Gas safety installation and use regulations 1998 plus all relevant safety and building regulations concerning fire installation**
- **Document J: Combustion appliances and fuel storage systems**

| | | |
|---|--|--|
| Model | : YORK LARGE 3 CF (Centre Fire) | |
| Gas | : NATURAL GAS | : BUTANE / PROPANE |
| Country | : GB; Great Britain/IE; Ireland | : GB; Great Britain/IE; Ireland |
| Product identification no | : 0063CM3684 | : 0063CM3684 |
| Type of appliance under CE-norm | : C ₁₁ / C ₃₁ / C _{31S} | : C ₁₁ / C ₃₁ / C _{31S} |
| Category of appliance | : I _{2E+} natural gas G20 | : I _{3B/P} butane/propane G30/G31 |
| Nominal heat input (Gross calorific value) | : 13.7 kW | : Butane (G30) : 11.7 kW Propane (G31): 10.0 kW |
| Nominal heat output | : 10.5 kW | : 7.7 - 9.0 kW |
| Efficiency class | : 1 (85%) | : 1 (85%) |
| NOx-class | : 5 | : 5 |
| Gas rate (max.) | : 1.28 m ³ /hr. | : Butane (G30) : 880 gr/hr. Propane (G31): 730 gr/hr. |
| Supply pressure | : 20.0 mbar | : Butane (G30) : 37.0 mbar Propane (G31): 37.0 mbar |
| Burner pressure (max.) Hot | : 15.0 mbar(*) | : 29.0 mbar(*) |
| Burner pressure (max.) Cold | : 14.3 mbar(**) | : 29.0 mbar(**) |
| Burner pressure (min.) | : 0.8 mbar(***) | : 3.0 mbar(***) |
| Primary air inlet burner Rear | : 1x Ø12.0 mm | : 1x Ø20.0 ^{+corner} mm + 2x Ø5.0 mm |
| Primary air inlet burner Front | : 1x Ø12.0 mm | : 1x Ø20.0 ^{+corner} mm + 2x Ø5.0 mm |
| Gas regulator block (remote control) | : Mertik GV 60 | : Mertik GV 60 |
| Main burner | : Centre Fire 694 x 130 mm | : Centre Fire 694 x 130 mm |
| Main burner injector Rear | : no 210 (= 1x Ø2.10 mm) | : no 110 (= 1x Ø1.10 mm) |
| Main burner injector Front | : no 210 (= 1x Ø2.10 mm) | : no 130 (= 1x Ø1.30 mm) |
| Pilot light burner | : SIT 0.145.019 | : SIT 0.145.019 |
| Pilot light burner injector | : no 36 (SIT 0.977.091) | : no 23 (SIT 0.977.150) |
| Gas connection | : 3/8" G / Ø12 mm | : 3/8" G / Ø12 mm |
| Concentric flue system connection | : Ø100 mm - Ø150 mm or Ø130 mm - Ø200 mm | : Ø100 mm - Ø150 mm or Ø130 mm - Ø200 mm |

| | | |
|---------------------------------|--|---------------------------|
| Model | : YORK LARGE 3 CF (Centre Fire) | |
| Gas | : NATURAL GAS | : BUTANE / PROPANE |
| Country | : GB; Great Britain/IE; Ireland | |
| Batteries remote control | | |
| - Receiver | : 4x 1.5V AA | : 4x 1.5V AA |
| - Hand-transmitter | : 1x 9V block | : 1x 9V block |
| Weight: | | |
| - Basis model | : 126 kg | : 126 kg |
| - Including all options | : 148 kg | : 148 kg |
| - Convection package | : 17 kg | : 17 kg |

(*) : Both burners at maximum. Appliance is on temperature.

(**) : Both burners at maximum. Appliance is cold.

(***) : Both burners at minimum.

Flue gas exhaust and combustion air supply:

Roof-mounted outlet : Concentric flue system Ø100 mm - Ø150 mm. Rigid and/or flexible.

Horizontal wall outlet : Concentric flue system Ø130 mm - Ø200 mm. Rigid.

With wall outlet, depending on the flue configuration; Ø100 mm - Ø150 mm or Ø130 mm - Ø200 mm.

Heat changing surface: Entire front of the appliance.

| | | |
|---|--|---|
| Model | : YORK LARGE 3 LF (Line Fire) | |
| Gas | : NATURAL GAS | : BUTANE / PROPANE |
| Country | : GB; Great Britain/IE; Ireland | : GB; Great Britain/IE; Ireland |
| Product identification no | : 0063CM3684 | : 0063CM3684 |
| Type of appliance under CE-norm | : C ₁₁ / C ₃₁ / C _{31S} | : C ₁₁ / C ₃₁ / C _{31S} |
| Category of appliance | : I _{2H} natural gas G20 | : I _{3B/P} butane/propane G30/G31 |
| Nominal heat input (Gross calorific value) | : 14.0 kW | : Butane (G30) : 13.5 kW Propane (G31): 11.5 kW |
| Nominal heat output | : 10.8 kW | : 8.8 - 10.4 kW |
| Efficiency class | : 1 (85%) | : 1 (85%) |
| NOx-class | : 5 | : 5 |
| Gas rate (max.) | : 1.33 m ³ /hr. | : Butane (G30) : 1030 gr/hr. Propane (G31): 850 gr/hr. |
| Supply pressure | : 20.0 mbar | : Butane (G30) : 37.0 mbar Propane (G31): 37.0 mbar |
| Burner pressure (max.) Hot | : 11.4 mbar(*) | : 29.0 mbar(*) |
| Burner pressure (max.) Cold | : 10.7 mbar(**) | : 29.0 mbar(**) |
| Burner pressure (min.) | : 1.3 mbar(***) | : 1.0 mbar(***) |
| Primary air inlet burner Rear | : 1x Ø12.0 mm | : 1x Ø20.0 ^{+corner} mm + 2x Ø5.0 mm |
| Primary air inlet burner Front | : 1x Ø12.0 mm | : 1x Ø20.0 ^{+corner} mm + 2x Ø5.0 mm |
| Gas regulator block (remote control) | : Mertik GV 60 | : Mertik GV 60 |
| Main burner | : Line Fire 694x130 mm | : Line Fire 694x130 mm |
| Main burner injector Rear | : no 210 (= 1x Ø2.10 mm) | : nr. 120 (= 1x Ø1.20 mm) |
| Main burner injector Front | : no 255 (= 1x Ø2.55 mm) | : nr. 140 (= 1x Ø1.40 mm) |
| Pilot light burner | : SIT 0.145.019 | : SIT 0.145.019 |
| Pilot light burner injector | : no 36 (SIT 0.977.091) | : no 23 (SIT 0.977.150) |
| Gas connection | : 3/8" G / Ø12 mm | : 3/8" G / Ø12 mm |
| Concentric flue system connection | : Ø100 mm - Ø150 mm or Ø130 mm - Ø200 mm | : Ø100 mm - Ø150 mm or Ø130 mm - Ø200 mm |

| | | |
|---------------------------------|--|--|
| Model | : YORK LARGE 3 LF (Line Fire) | |
| Gas | : NATURAL GAS | : BUTANE / PROPANE |
| Country | : GB; Great Britain/IE; Ireland | : GB; Great Britain/IE; Ireland |
| Batteries remote control | | |
| - Receiver | : 4x 1.5V AA | : 4x 1.5V AA |
| - Hand-transmitter | : 1x 9V block | : 1x 9V block |
| Weight: | | |
| - Basis model | : 126 kg | : 126 kg |
| - Including all options | : 148 kg | : 148 kg |
| - Convection package | : 17 kg | : 17 kg |

(*) : Both burners at maximum. Appliance is on temperature.

(**) : Both burners at maximum. Appliance is cold.

(***) : Both burners at minimum.

Flue gas exhaust and combustion air supply:

Roof-mounted outlet : Concentric flue system Ø100 mm - Ø150 mm. Rigid and/or flexible.

Horizontal wall outlet : Concentric flue system Ø130 mm - Ø200 mm. Rigid.

With wall outlet, depending on the flue configuration; Ø100 mm - Ø150 mm or Ø130 mm - Ø200 mm.

Heat changing surface: Entire front of the appliance.

8 REPLACEMENT PARTS LIST

When requesting service or ordering replacement parts, please quote the model type and serial number. All parts listed in this manual may be ordered from a Bellfires dealer.

| No | Article no | Description |
|----|------------|--|
| 1 | 335116 | Main burner "Centre Fire" 694 x 130 mm <u>Natural gas G20 / Butane/Propane G30/G31</u> G20: 1x Ø12.0 mm front + 1x Ø12.0 mm rear G30/G31: 1x Ø20.0 ^{+corner} mm + 2x Ø5.0 mm front and 1x Ø20.0 ^{+corner} mm + 2x Ø5.0 mm rear |
| 2 | 335112 | Burner mat L = 694 mm "Centre Fire" |
| 3 | 334876 | Main burner injector <u>Natural gas</u> ; Front: no 210 (1x Ø2.10 mm) |
| 4 | 334876 | Main burner injector <u>Natural gas</u> ; Rear: no 210 (1x Ø2.10 mm) |
| 5 | 301928 | Main burner injector <u>Butane/Propane</u> ; Front: no 130 (1x Ø1.30 mm) |
| 6 | 334992 | Main burner injector <u>Butane/Propane</u> ; Rear: no 110 (1x Ø1.10 mm) |
| 7 | 335117 | Main burner "Line Fire" 694 x 130 mm <u>Natural gas G20 / Butane/Propane G30/G31</u> G20: 1x Ø12.0 mm front + 1x Ø12.0 mm rear G30/G31: 1x Ø20.0 ^{+corner} mm + 2x Ø5.0 mm front and 1x Ø20.0 ^{+corner} mm + 2x Ø5.0 mm rear |
| 8 | 335113 | Burner mat L = 694 mm "Line Fire" |
| 9 | 301909 | Main burner injector <u>Natural gas</u> ; Front: no 255 (1x Ø2.55 mm) |
| 10 | 334876 | Main burner injector <u>Natural gas</u> ; Rear: no 210 (1x Ø2.10 mm) |
| 11 | 334878 | Main burner injector <u>Butane/Propane</u> ; Front: no 140 (1x Ø1.40 mm) |
| 12 | 334874 | Main burner injector <u>Butane/Propane</u> ; Rear: no 120 (1x Ø1.20 mm) |
| 13 | 333597 | Gas regulator block; GV 60 (M10 Thermocouple connection) |
| 14 | 302122 | 3/8" male x Ø12 Compression fitting |
| 15 | 302084 | Nut Ø8 mm for burner supply GV 60 for "front burner" |
| 16 | 302089 | Olive Ø8 mm for burner supply GV 60 for "front burner" |
| 17 | 333607 | Gas valve "rear burner" |
| 18 | 333608 | Adapter 3/8"bsp x 3/8"+ O-ring |
| 19 | 333610 | Nut Ø8 mm for gas valve "rear burner" |
| 20 | 333611 | Olive Ø8 mm for gas valve "rear burner" |
| 21 | 302086 | Cut-off nipple Ø4 mm GV 60 |
| 22 | 333601 | Cable (sw): Receiver - Thermocouple interrupter, L = 500 mm |
| 23 | 333602 | Cable (tc): Receiver - Thermocouple interrupter, L = 500 mm |
| 24 | 333598 | Hand-held transmitter: Display screen: Temperature and two programmes |
| 25 | 333599 | Cover battery compartment hand-held transmitter - with imprint: Operating double burner |
| 26 | 333600 | Receiver GV 60 - EU |
| 27 | 302068 | 8 Wire connecting cable Gas regulator block - Receiver, L = 500 mm |
| 28 | 302421 | Piezo ignition cable, 2x \sphericalangle 2.8 x 0.8 mm, L = 1500 mm |

| No | Article no | Description |
|----|------------|---|
| 29 | 321926 | Thermocouple M10 - 1500 mm |
| 30 | 333604 | Thermocouple interrupter M10 |
| 31 | 310908 | Pilot light set outer casing, Double flame |
| 32 | 310909 | Packing pilot light set outer casing |
| 33 | 310910 | Pilot light injector; <u>Natural gas</u> ; no 36 |
| 34 | 310912 | Pilot light injector; <u>Butane/Propane</u> ; no 23 |
| 35 | 310907 | Piezo electrode for pilot light, 2.8 x 0.5 mm |
| 36 | 302062 | Nut piezo electrode |
| 37 | 319842 | Nut thermocouple |
| 38 | 332552 | Pilot light olive; Ø4 mm, steel |
| 39 | 332553 | Pilot light nut; Ø4 mm, steel |
| 40 | 322552 | Pilot light pipe; Ø4 mm, L = 1500 mm, Flexible, Stainless steel |
| 41 | 325750 | Burner pipe; Ø8 mm, L = 1500 mm, Flexible, Stainless steel - 10 kW+, "front burner" |
| 42 | 325750 | Burner pipe; Ø8 mm, L = 1500 mm, Flexible, Stainless steel - 10 kW+, "rear burner" |
| 43 | 326055 | Nut; Ø8 mm, compression elbow main burner |
| 44 | 326054 | Olive; Ø8 mm, compression elbow main burner |
| 45 | 331294 | Glass York Large 3 Hidden Door (990 x 642 x 4 mm) |
| 46 | 331293 | Glass York Large 3 Floating Frame (982 x 648 x 4 mm) |
| 47 | 301669 | Tube ceramic glue |
| 48 | 301593 | Black fibre glass tape 15 x 3 mm, adhesive |
| 49 | 319664 | Black fibre glass tape 30 x 2 mm, adhesive |
| 50 | 311006 | Black fibre glass tape 20 x 2 mm, adhesive |
| 51 | 301617 | Black fibre glass cord Ø10 mm |

Logs - Chips of wood - Embers - Vermiculite granules - Marble pebbles

| Appliance | Log set | | | | | | | | | | | Marble pebbles set (white) | Marble pebbles set (grey) | |
|--------------|----------|--------|--------|--------|--------|--------|--------|--------|--------|-------------------|------------------------------------|---------------------------------|---------------------------|--------------|
| | Set | Log no | | | | | | | | Chips of wood set | Embers with Glow-effect Anthracite | Vermiculite no 4 black filtered | | |
| | | 1 | 2 | 3 | 4 | 5 | 6 | 7 | 8 | 3 pieces | Bag: 125 gr. | Bag: 50 gr. | Bag: 2.5 kg. | Bag: 2.5 kg. |
| Art. no: | 331357 | 331358 | 331359 | 331360 | 331361 | 331362 | 331363 | 331364 | xxxxxx | 301863 | 332583 | 310937 | 325758 | |
| York Large 3 | I 332585 | 1x | 1x | 1x | 1x | 1x | 1x | 1x | - | 1x | 3x | 1x | 3x | 3x |

9 DISPOSING OF PACKAGING AND APPLIANCE

The appliance comes in recyclable packaging.

This can include:

- Cardboard
- Wood
- Plastic
- Paper

Such materials must be disposed of responsibly, in line with local regulations.

Batteries should be disposed of as chemical waste. Batteries must be disposed of responsibly, in line with local regulations.

The authorities or fitter can provide you with information on responsible disposal of obsolete appliances.



Your Bellfires dealer

01 - 011114 - 335743