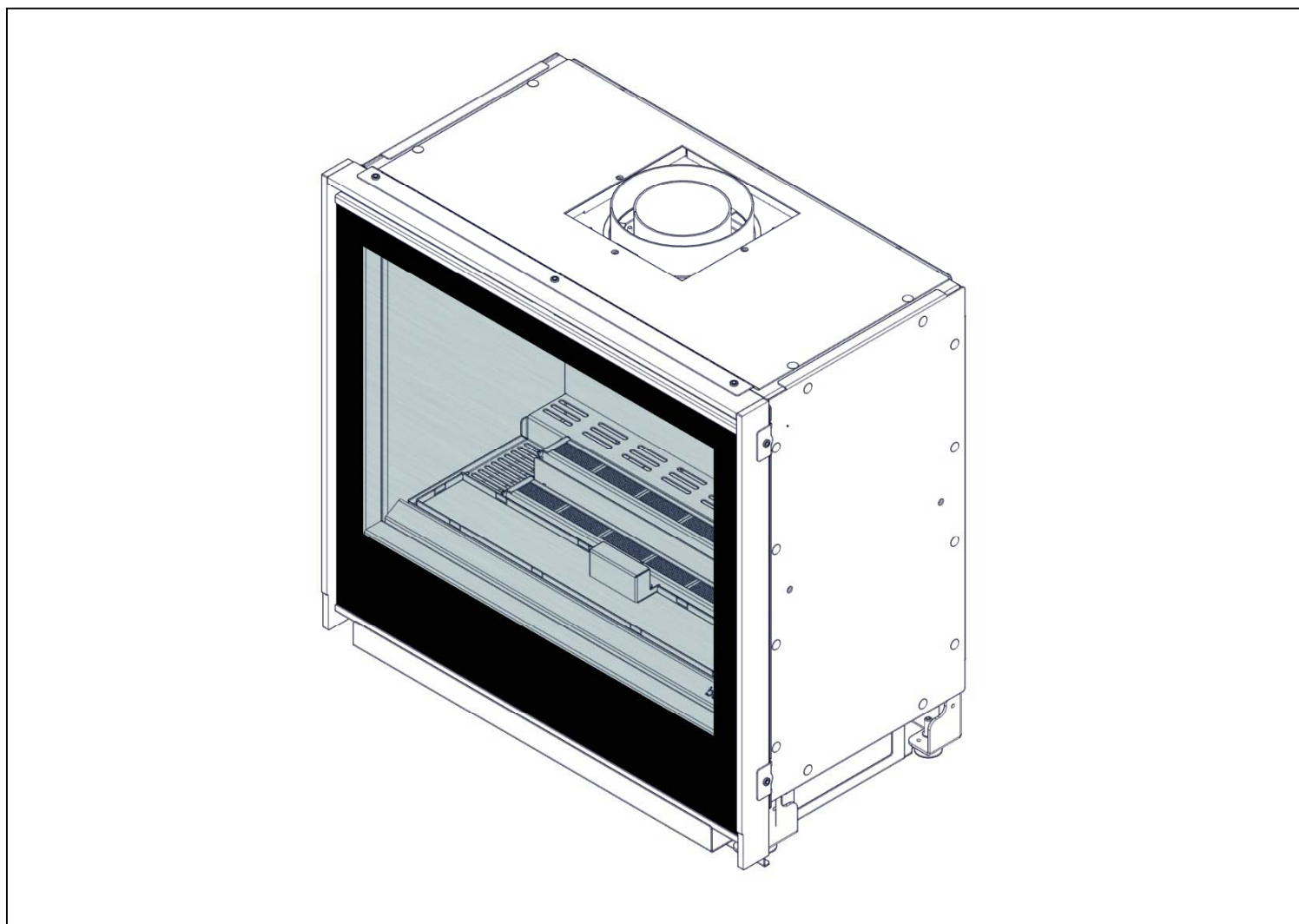


# bellfires. <sup>gas fires</sup>

## Preparation manual

### Smart Bell 75/60 MF



Serial number:

Production date:

© **Barbas Bellfires BV**

This document or parts thereof may not be reproduced, stored in a retrieval system, or transmitted, in any form or by any means, electronic, mechanical, photocopying, recording, nor otherwise, without the prior written permission of Barbas Bellfires BV. This document could contain technical inaccuracies or typographical errors. Barbas Bellfires BV reserves the right to revise this document from time to time in the contents thereof.

**Contact information**

Barbas Bellfires BV

Hallenstraat 17, 5531 AB Bladel, The Netherlands

Phone: +31 49 733 9200

E-mail: [info@bellfires.com](mailto:info@bellfires.com)

# Contents

<b>1</b>	<b>About this document.....</b>	<b>4</b>
1.1	How to work with this document.....	4
1.2	Warnings and cautions used in this document.....	4
1.3	Related documentation.....	4
<b>2</b>	<b>Overview of the concentric flue system.....</b>	<b>5</b>
<b>3</b>	<b>Safety.....</b>	<b>6</b>
3.1	Safety instructions for installation.....	6
<b>4</b>	<b>Requirements.....</b>	<b>7</b>
4.1	Requirements on the location.....	7
4.2	Other requirements.....	7
4.3	Requirements on the outlet.....	7
4.3.1	Requirements on the roof outlet.....	7
4.3.2	Requirements on the wall outlet.....	8
4.4	Requirements on the concentric flue system.....	9
4.4.1	Possibilities for a concentric flue system with a roof outlet.....	10
4.4.2	Possibilities for a concentric flue system with a wall outlet.....	16
<b>5</b>	<b>Technical specification.....</b>	<b>17</b>
5.1	Dimensions Smart Bell 75/60 with a Built-in frame.....	17
5.2	Dimensions Smart Bell 75/60 with a Classic frame 35 mm.....	18
5.3	Dimensions Smart Bell 75/60 with a Classic frame 52 mm.....	19
5.4	Dimensions Smart Bell 75/60 with a Classic frame 70 mm.....	20
5.5	Dimensions Smart Bell 75/60 with an Insert frame 15 mm.....	21
5.6	Dimensions Smart Bell 75/60 with an Insert frame 50 mm.....	22
5.7	Dimensions Smart Bell 75/60 with an Insert frame 50 mm and Convection fan.....	23
5.8	Dimensions of the restriction plate.....	23
<b>6</b>	<b>Available components for the concentric flue system.....</b>	<b>24</b>
6.1	Appliance part list.....	24
6.2	Bellfires - Muelink & Grol system Ø100 - Ø150.....	25
6.3	Poujoulat - DUOGAS system Ø100 - Ø150.....	29
6.4	Ontop - Metaloterm US system Ø100 - Ø150.....	32
6.5	Jeremias/STB - H-Twin system Ø100 - Ø150.....	36
6.6	Jeremias - TWIN-GAS system Ø100 - Ø150.....	40

# 1 About this document

This document shows the necessary information to do these tasks on the Smart Bell 75/60 MF:

- Preparation for installation

This document refers to the Smart Bell 75/60 MF as 'the appliance'. This document is an essential part of your appliance. Read it carefully before you do work on the appliance. Keep it in a safe place.

The original instructions of the document are in English. All other language versions of the document are translations of the original instructions. It is not always possible to provide a detailed illustration of every single item of the equipment. The illustrations in this document show a typical setup. The illustrations are for instructional use only.

## 1.1 How to work with this document

1. Make yourself familiar with the structure and content of the document.
2. Read the safety chapter in detail.
3. Make sure that you understand all the instructions.
4. Do the procedures completely and in the given sequence.

## 1.2 Warnings and cautions used in this document

### Warning



If you do not obey these instructions, there is a risk that can cause personal injury or death.

### Caution

If you do not obey these instructions, there is a risk of damage to the equipment or to property.

### Note

A note shows more information.

Symbol	Description
	Visual sign that there is a hazard
	Visual sign that there is a notice

## 1.3 Related documentation

- Preparation manual
- Installation and maintenance manual
- User manual

## 2 Overview of the concentric flue system

The concentric flue system provides the appliance with combustion air and removes the flue gases from the appliance. The concentric flue system is made of these items:

Item	Description
Concentric flue	The concentric flue is a pipe with an inner pipe. The inner pipe is used as flue gas channel and the space between the inner pipe and the outer pipe is used as combustion air channel
Flue gas channel	The flue gases from the appliance flow through the channel to the outlet by a natural draft
Combustion air channel	Supplies the appliance with fresh air from the outlet through the channel
Outlet/terminal	Entry for the combustion air channel and exit for the flue gas channel

## 3 Safety

### 3.1 Safety instructions for installation



**Caution:**

- The appliance must be installed as a 'room sealed system' appliance by a certified and registered gas installation engineer in accordance with the supplied installation instructions, and nationally and locally applicable regulations.
- If you have any questions regarding the installation, consult your local gas company.
- Only use items in the installation that are specified in this manual and the related documents.
- Only use the following brands for the installation of the concentric flue system:

Manufacturer	system
Belfires	Muelink & Grol system
Poujoulat	DUOGAS system
Ontop	Metaloterm US system
Jeremias/STB (STB = Schoorsteen Techniek Brummen NL)	H-Twin system
Jeremias	TWIN-GAS system

- Do not use a combination of parts from different brands for the installation of the concentric flue system.
- Before beginning the installation, check that the details on the rating plate correspond to the gas type and supply pressure to which the appliance will be connected.

## 4 Requirements

### 4.1 Requirements on the location

- Never use combustible building materials for the fireplace.
- Do not install the appliance against a flammable rear wall.
- Install a nonflammable insulation plate of at least 12 mm between the appliance and the rear wall. The insulation plate must cover the entire area of the rear of the appliance.
- The appliance must be installed approximately 2 cm from the rear wall.
- If the fire burns in the appliance, make sure that the floor temperatures below and in front of the appliance cannot be higher than 85 °C .
- Make sure that the room where the appliance is installed is properly ventilated.

### 4.2 Other requirements

- The gas supply connection is located under in the appliance for an easy connection to all directions.
- Only use gas piping of at least 1/2" and a shut-off valve to connect the gas supply to the gas regulator block of the appliance.
- Make sure that there is a wall socket with earth connection nearby the appliance. The socket must be accessible at all times. The powercable (+ 0.5 m) is coming from the rear of the appliance.
- Install the fireplace on a solid floor that can bear the weight of the appliance and the fireplace.
- If the floor is made of flammable material, take correct safety measures. Install a temperature protection plate made of nonflammable material between the appliance and the floor.
- The appliance must be installed into an existing open fireplace or as a built-in appliance in a new fireplace.
- If the concentric flue system is installed in a chimney that is used for wood or coal fire, clean the chimney.
- If you built a new fireplace, make sure that it is ventilated with vents at the bottom and top of the fireplace. If the fireplace is not ventilated the temperature of the appliance can increase to dangerous temperatures and damage the fireplace.
- Keep a minimum distance between the appliance and a front wooden fireplace surround; with a depth of less than 10 cm, of:
  - 5 cm on the sides: (minimum distance: side appliance - leg wooden fireplace surround)
  - 40 cm at the top: (minimum distance: top appliance - bottom of beam wooden fireplace surround) The temperature on the underside of the beam of the wooden fireplace must never exceed 85°C. Optional: insulate the bottom of the wooden beam with a fireproof plate.

### 4.3 Requirements on the outlet

#### 4.3.1 Requirements on the roof outlet

Make sure that the outlet is installed at least 0.5 meter from the edge of the roof.



**Note:**

All the minimum distances are guidelines. Consult your national and local directives for the exact minimum distances.



Location of any of the items(*)	Minimum distance between the items and the roof outlet
At the same roof as the outlet	3 m
At a different roof as the outlet	1 m
At a lower positioned wall than the outlet	1 m
At a higher sloping surface than the outlet	3 m

(\*) Items:

- A ventilation opening that services an occupied room, a toilet or a bathroom.
- A combustion air supply, if the supply flows through an occupied room.
- A window that can be opened that services an occupied room, a toilet or a bathroom.

### 4.3.2 Requirements on the wall outlet

Make sure that the outlet is installed at least 0.5 meter from:

- The corner of a building
- the edge of the roof
- The roof overhang and rain gutter
- Balconies etc. unless the exhaust construction extends to at least the face of the protruding section



**Note:**

All the minimum distances are guidelines. Consult your national and local directives for the exact minimum distances.

If the outlet is installed horizontally in less than 0.5 m and vertically in less than 2 m from a public area, install an effective protector. Make sure that the mesh size of the guard does not affect the operation of the appliance.

If the height of the outlet is less than 3 meter from the floor, the distance between the outlet and a garden or a terrace must be at least 2 meter.

Location of any of the items(*)	Minimum distance between the items and the wall outlet
On a wall where the item services a living space other than that of the owner of the fireplace.	Do not install the wall outlet under an item.
On a wall (**)	<ul style="list-style-type: none"> <li>• Below the item: 2 m</li> <li>• Above the item: 0.75 m</li> <li>• Left or right of the outlet: 0.75 m</li> </ul>
within 1 meter of the roof overhang	2 m
Under a balcony, walkway, etc.	2 meter from the underside of the balcony or walkway
Under a balcony, walkway, etc. if the outlet extends to the front	2 m
A facing wall less than 2 meters from the outlet.	Apply the minimum distance for items on a wall.



(\*) Items:

- A ventilation opening that services an occupied room, a toilet or a bathroom.
- A combustion air supply, if the supply flows through an occupied room.
- A window that can be opened that services an occupied room, a toilet or a bathroom.

(\*\*) If an obstruction protrudes at least 0.5 meter between the item and the outlet and the obstruction has a length of at least the recommended minimum distance, ignore the recommended minimum distance.

## 4.4 Requirements on the concentric flue system

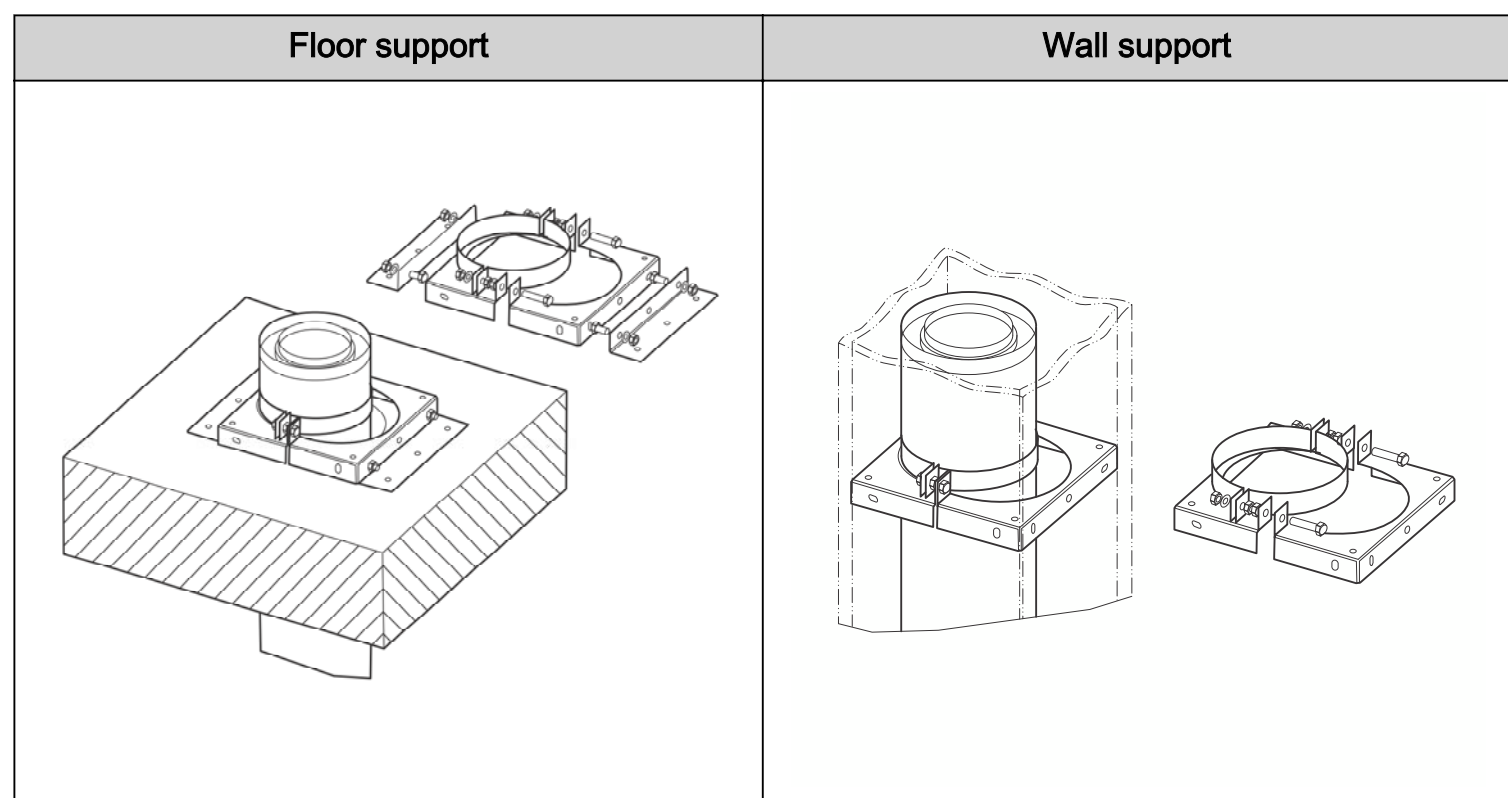


**Caution:**

- Make sure that no flammable materials are located close to the flue system. The outer walls of the flue system can be 150 °C.
- Make sure that the concentric flue system is in a casing.
  - Make sure that the casing is made of heat resistant material.
  - Make sure that air can flow in the casing. Use grates near the floor and near the ceiling. Do this for every floor where the casing is located.
- Do not insulate the concentric flue.

The parts that are required for the installation of the concentric flue system are numbered in the illustrations and refer to the part list in [6](#).

Use the universal wall/floor support (number 36 in the part list) to attach the concentric flue system to the casing and/or the floor.

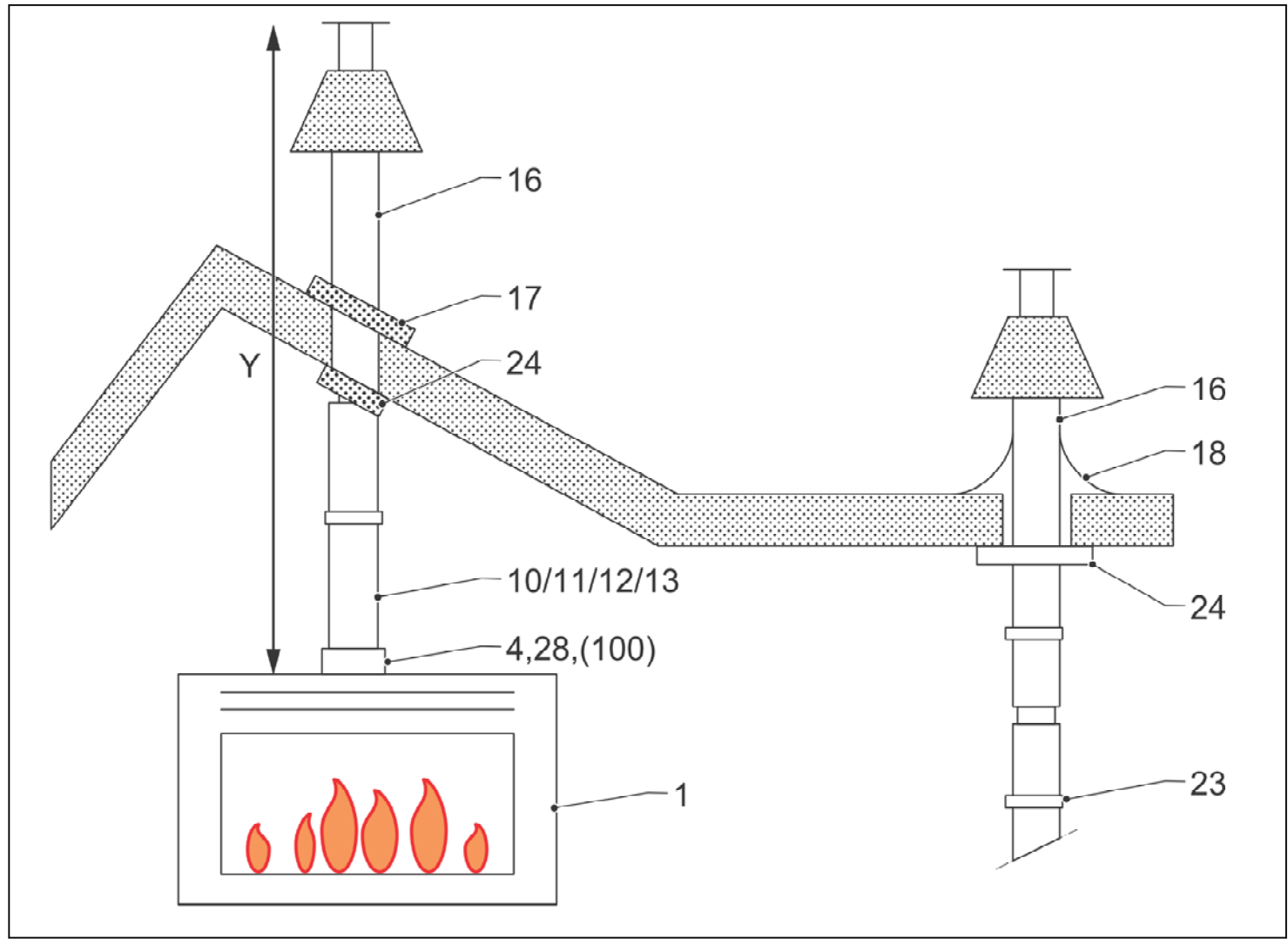


Install a concentric flue system as described in this section.

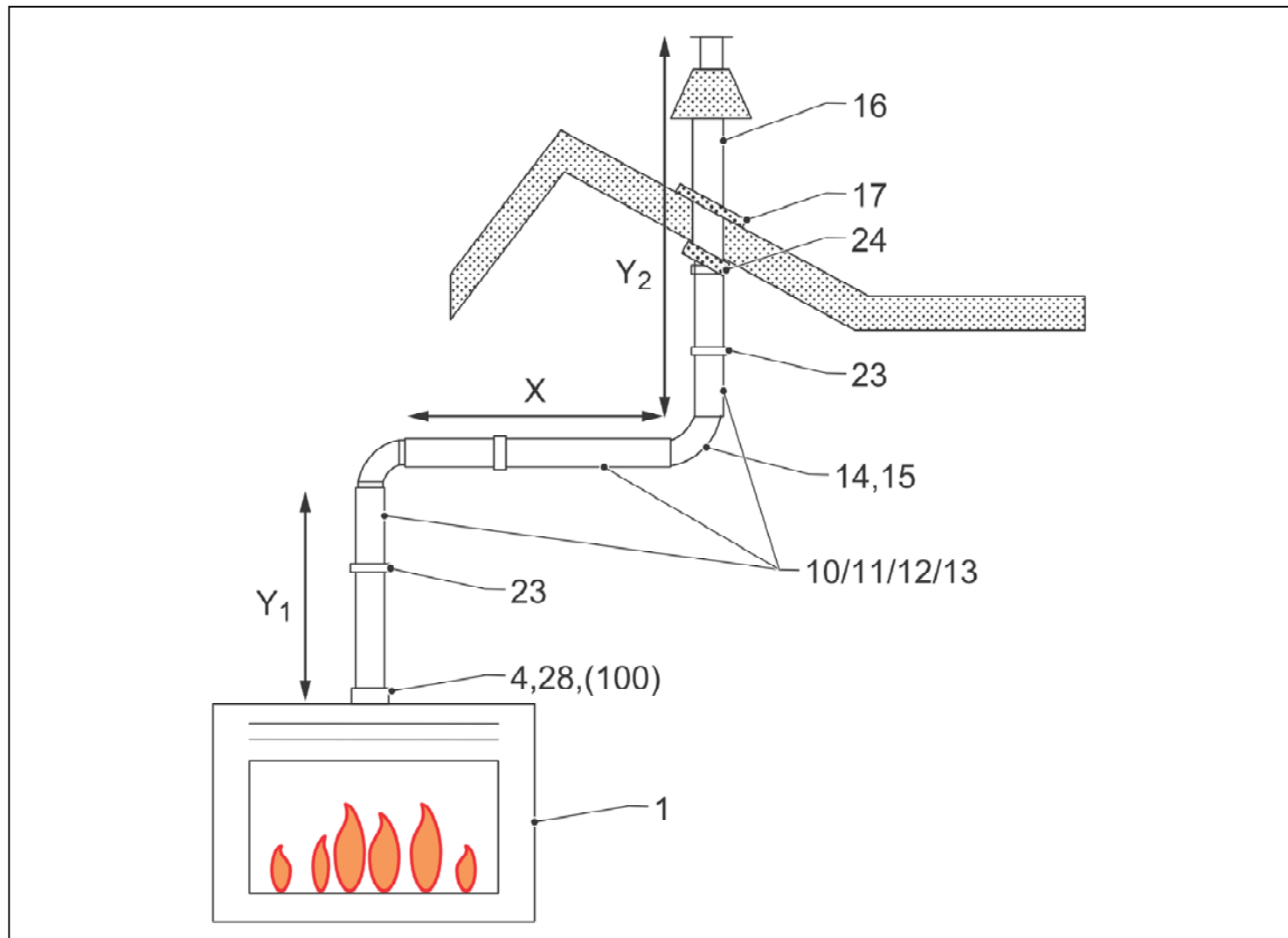
Some configurations of the concentric flue system require the installation of a flue restriction plate. Different sizes of the flue restriction plate are delivered with the appliance. Refer to the Installation and maintenance manual.

4.4.1 Possibilities for a concentric flue system with a roof outlet

Rigid concentric flue systems



	Y (min. - max.)	Flue gas restriction plate width
		Concentric connection on the appliance is Ø100-Ø150 mm
	2.0 - 4.0 m	30 mm
	4.0 - 12.0 m	40 mm



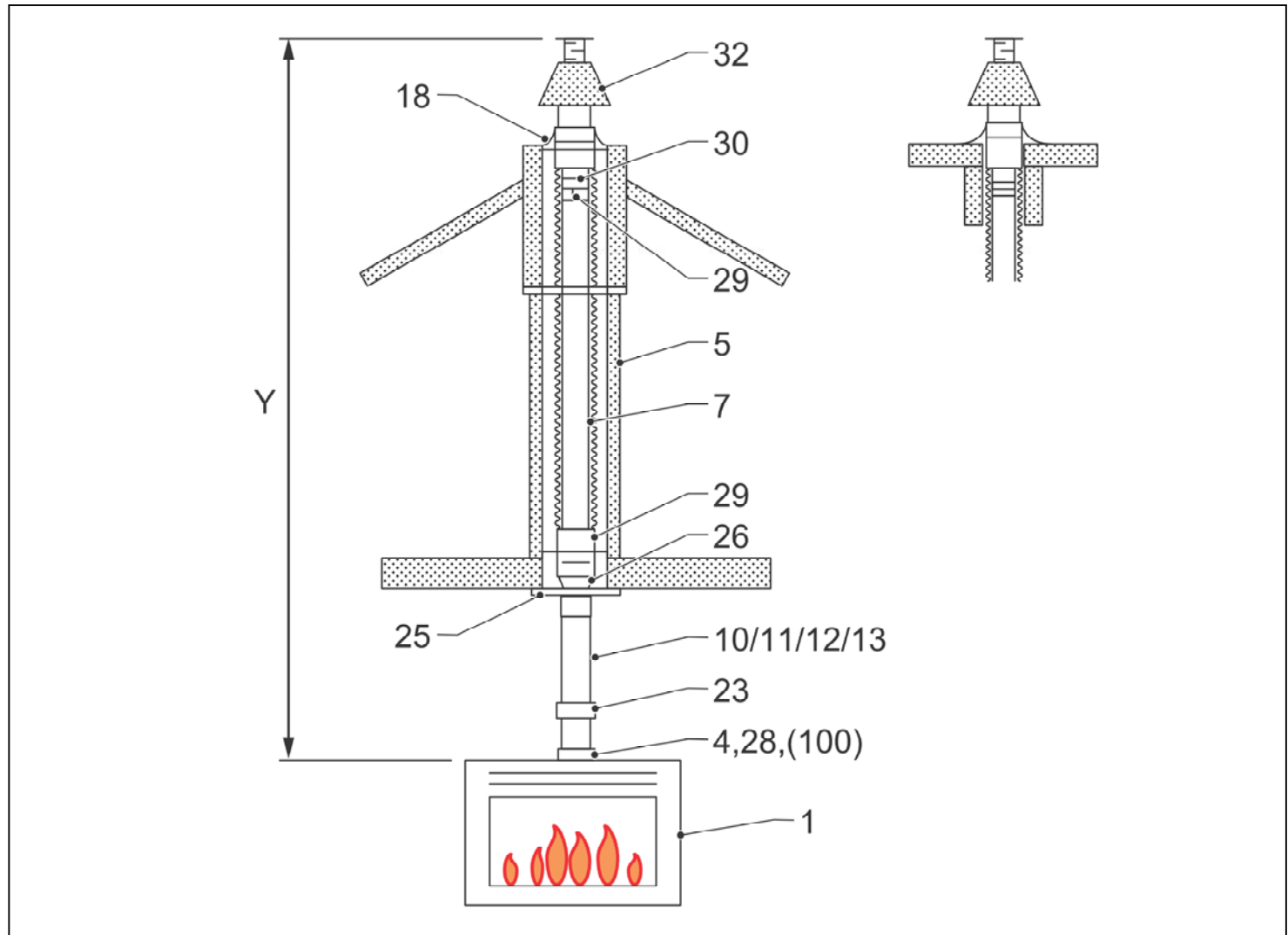
Y <sub>1</sub> (min. - max.)	X (min. - max.)	Y <sub>1</sub> + Y <sub>2</sub> (min. - max.)	Flue gas restriction plate width
			Concentric connection on the appliance is Ø100-Ø150 mm
1.0 - 11.0 m	0 - 3.0 m	1.0 - 11.0 m	-



**Caution:**

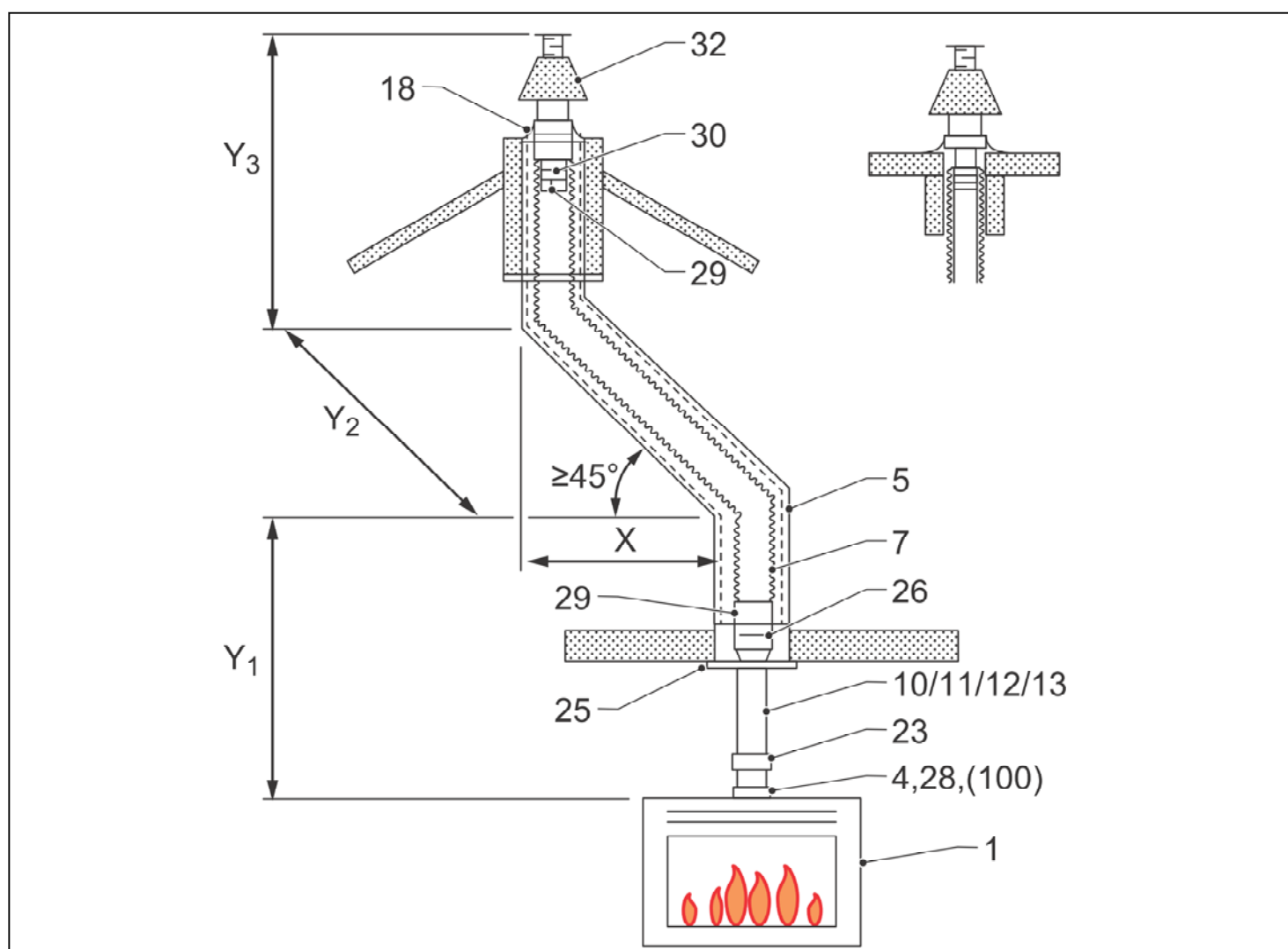
Make sure that Y<sub>1</sub> + Y<sub>2</sub> is at least 2 times larger than X.

**Flexible concentric flue systems**



	Y (min. - max.)	Flue gas restriction plate width	
		Concentric connection on the appliance is Ø100-Ø150 mm	
	2.0 - 4.0 m	30 mm	
	4.0 - 12.0 m	40 mm	

Roof outlet using an flexible Ø100 mm liner in an existing lined chimney.



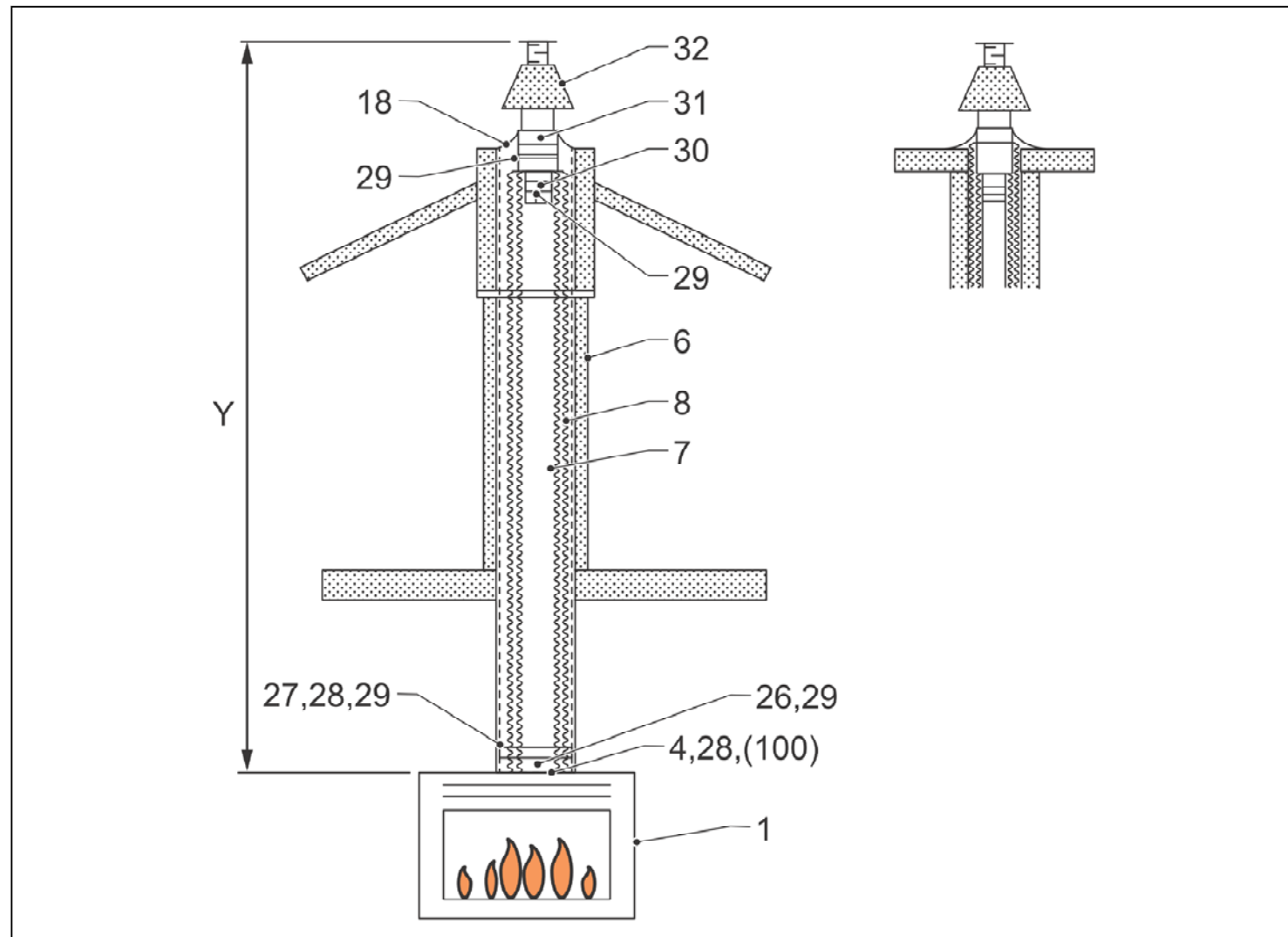
Y <sub>1</sub> (min. - max.)	X (min. - max.)	Y <sub>1</sub> + Y <sub>2</sub> + Y <sub>3</sub> (min. - max.)	Flue gas restriction plate width
			Concentric connection on the appliance is Ø100-Ø150 mm
1.0 - 11.0 m	0 - 3.0 m	1.0 - 11.0 m	-



**Caution:**

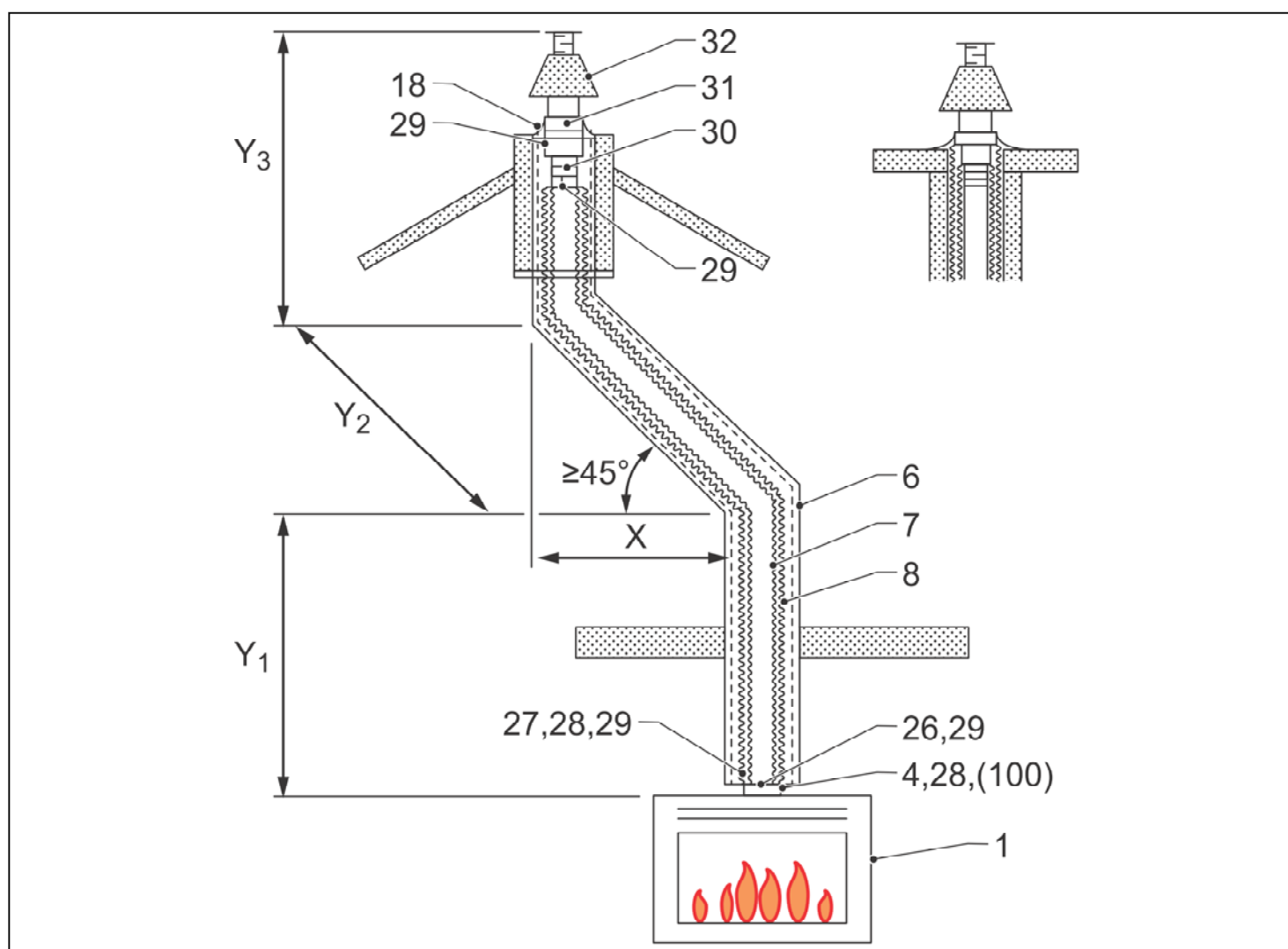
Make sure that  $Y_1 + Y_2 + Y_3$  is at least 2 times larger than X.

Roof outlet using an flexible Ø100 mm liner in an existing lined chimney.



	Y (min. - max.)	Flue gas restriction plate width
		Concentric connection on the appliance is Ø100-Ø150 mm
	2.0 - 4.0 m	30 mm
	4.0 - 12.0 m	40 mm

Roof outlet using an flexible Ø100 mm liner and flexible Ø150 mm liner in an existing unsound lined chimney.



Y <sub>1</sub> (min. - max.)	X (min. - max.)	Y <sub>1</sub> + Y <sub>2</sub> + Y <sub>3</sub> (min. - max.)	Flue gas restriction plate width
			Concentric connection on the appliance is Ø100-Ø150 mm
1.0 - 11.0 m	0 - 3.0 m	1.0 - 11.0 m	-



**Caution:**

Make sure that  $Y_1 + Y_2 + Y_3$  is at least 2 times larger than X.

Roof outlet using an flexible Ø100 mm liner and flexible Ø150 mm liner in an existing unsound lined chimney.

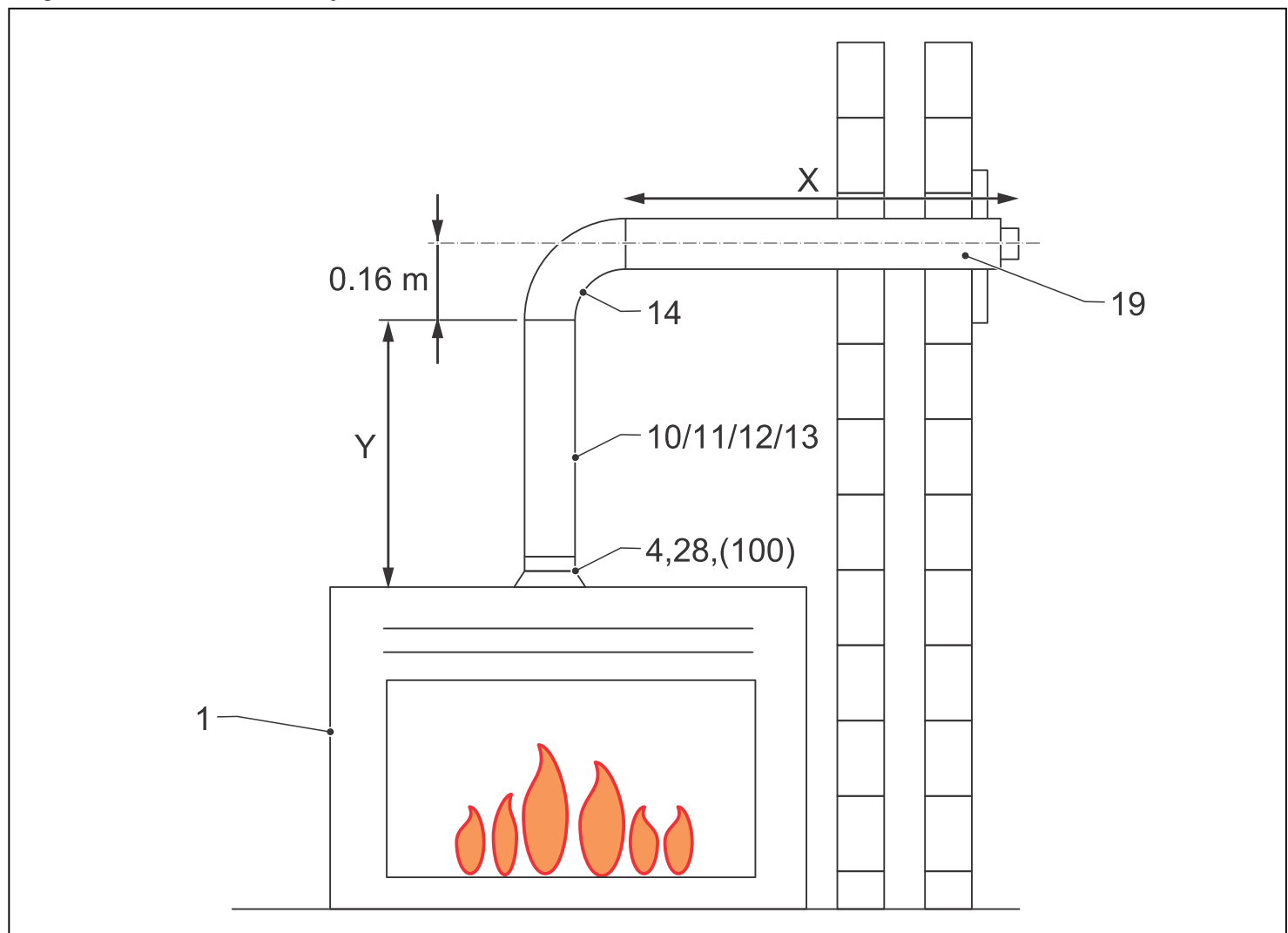


**4.4.2 Possibilities for a concentric flue system with a wall outlet**

Install the wall outlet in the correct position as shown in the figure. The centre of the inner pipe must be positioned above the centre of the outer pipe.



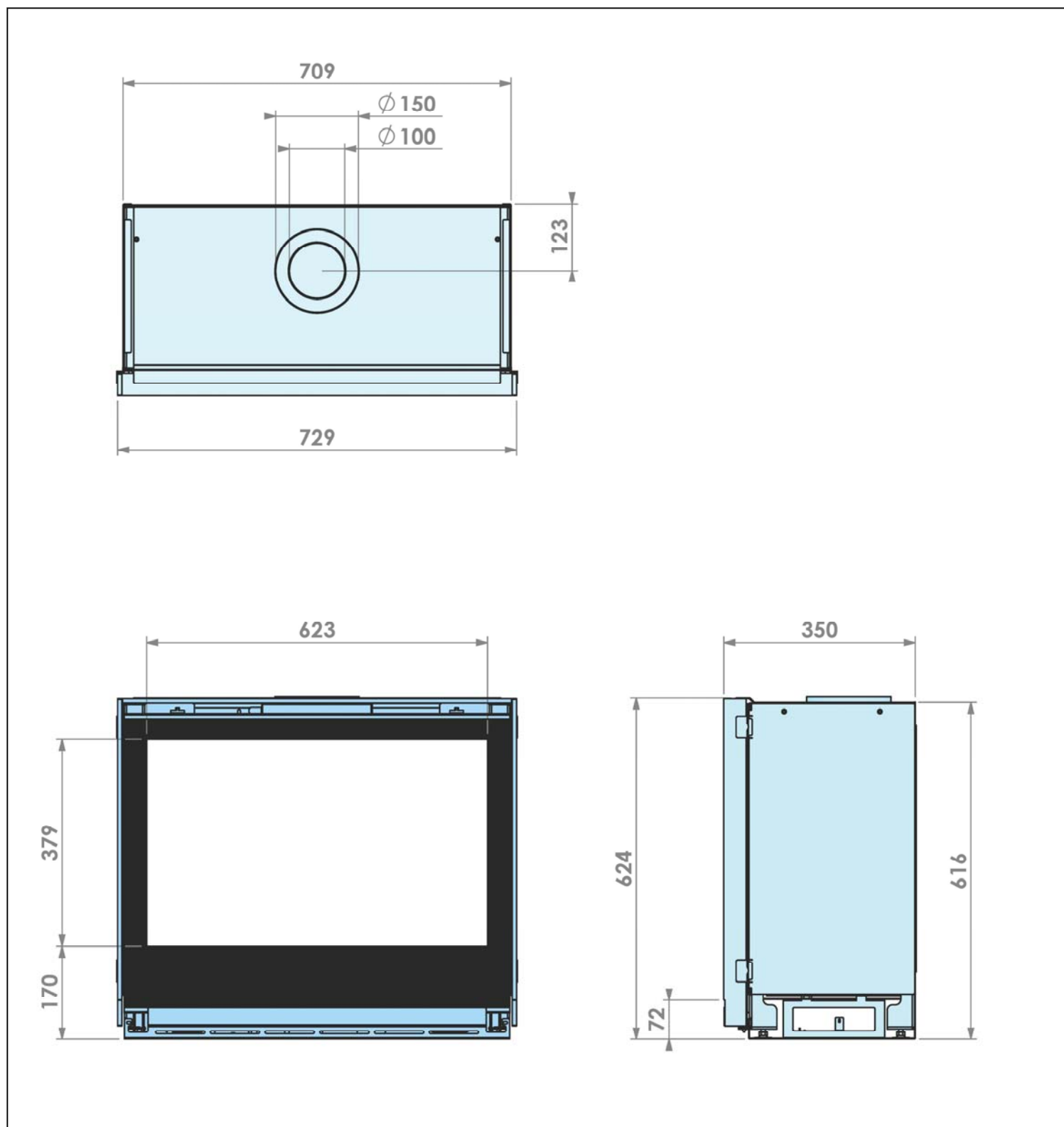
**Rigid concentric flue systems**



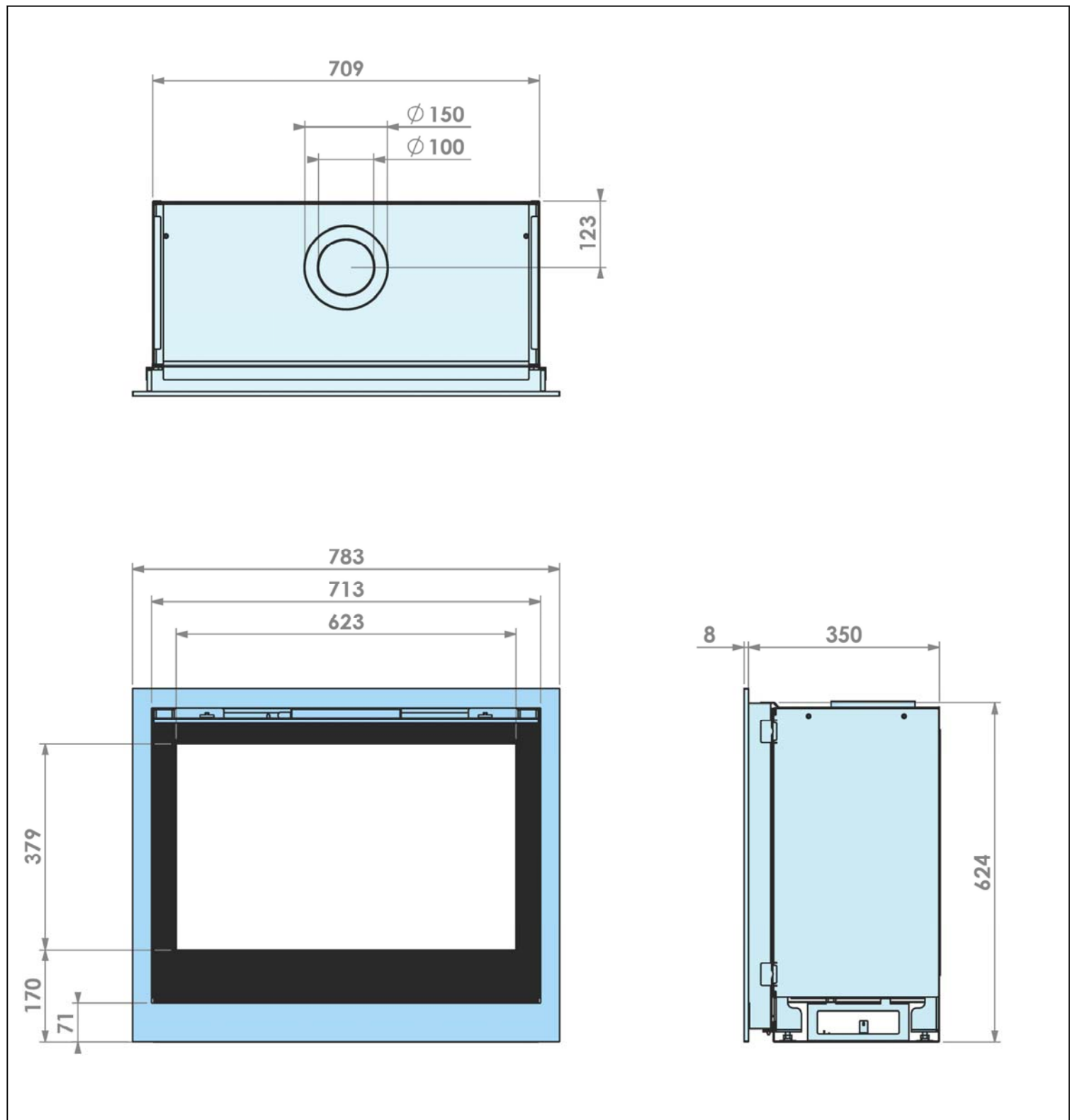
	Y (min. - max.)	X (min. - max.)	Flue gas restriction plate width
			Concentric connection on the appliance is Ø100-Ø150 mm
	1.0 - 2.5 m	0 - 3.5 m	-
	2.5 - 5.0 m	0 - 8.0 m	-

## 5 Technical specification

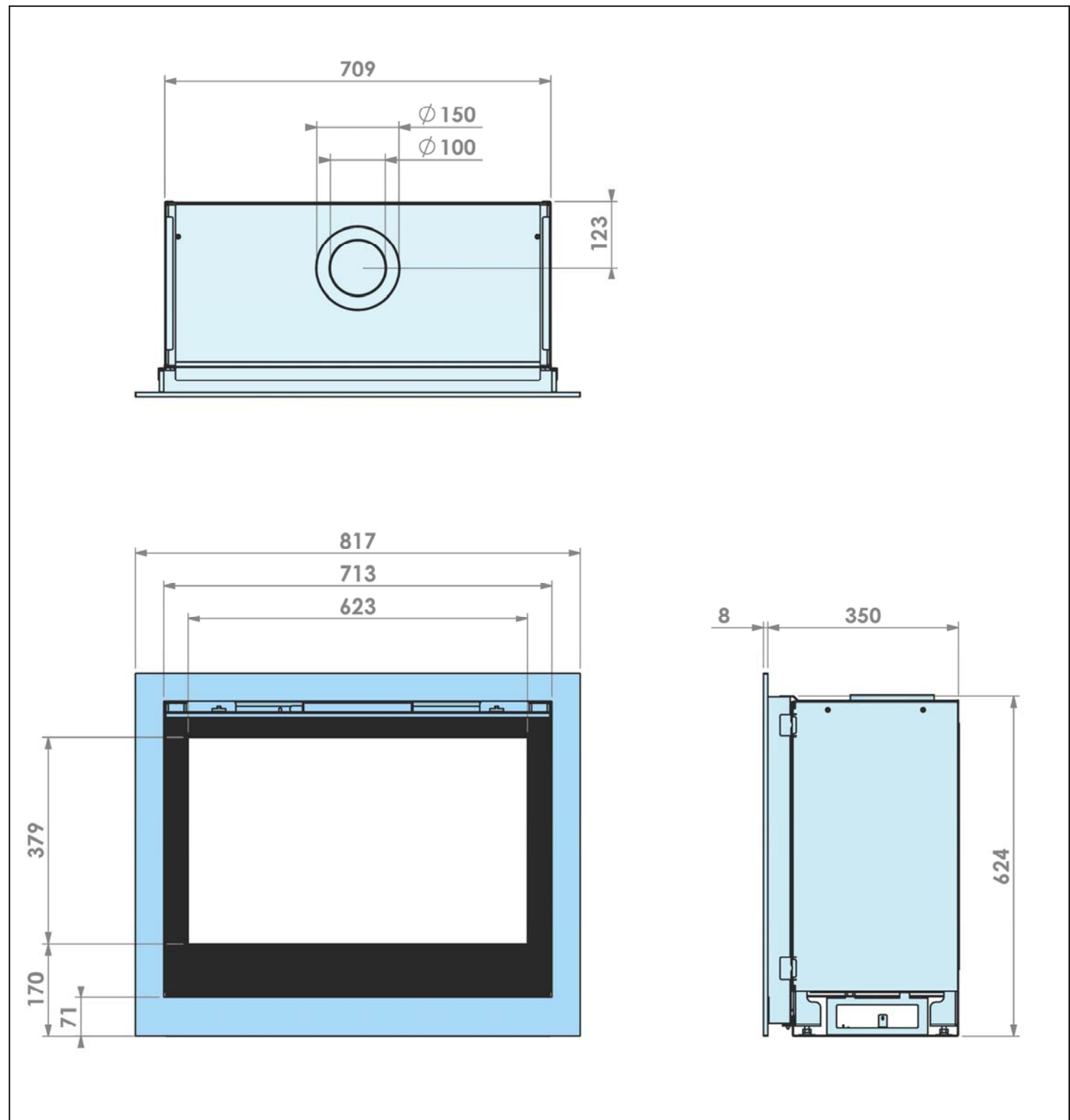
### 5.1 Dimensions Smart Bell 75/60 with a Built-in frame



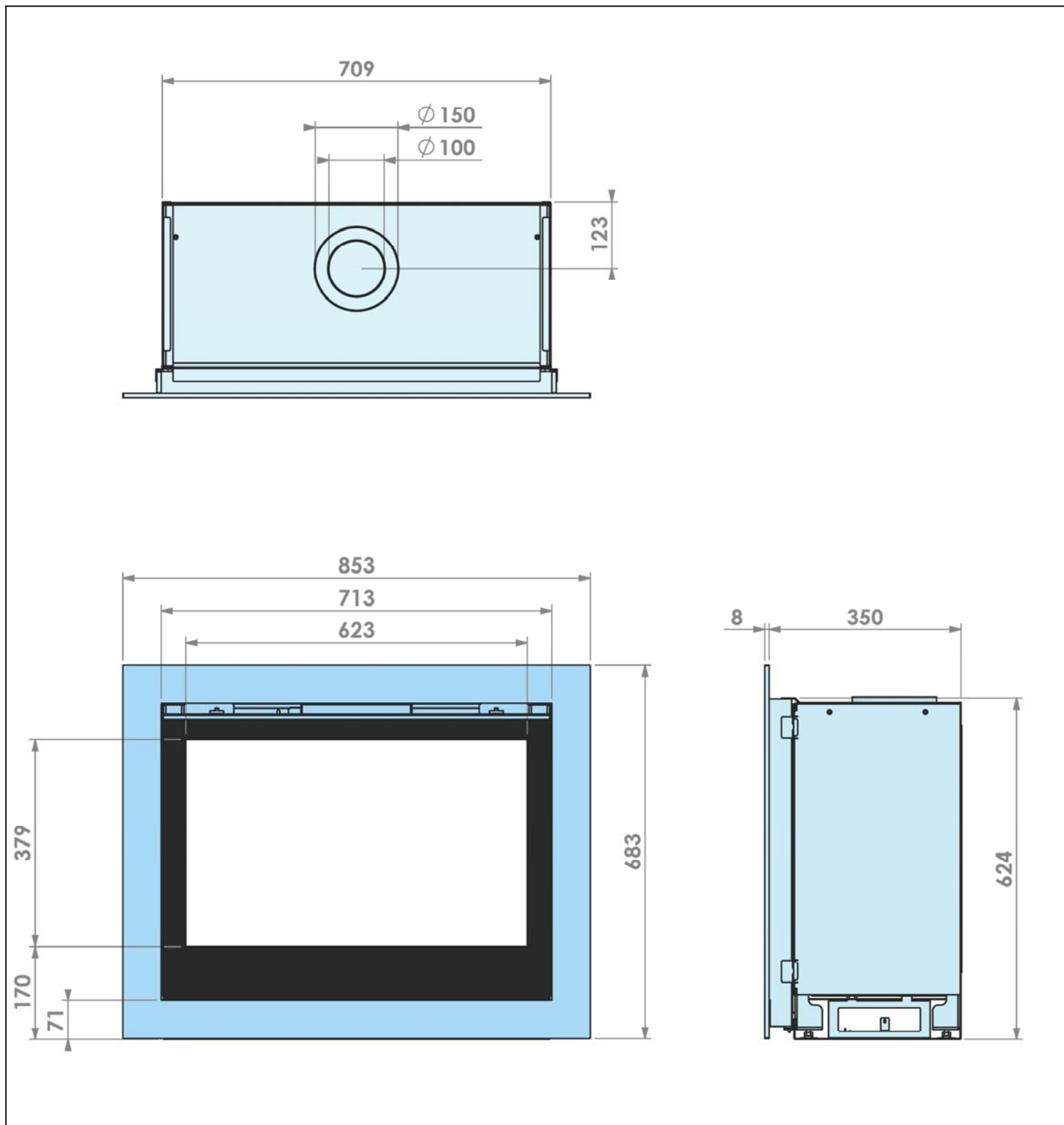
## 5.2 Dimensions Smart Bell 75/60 with a Classic frame 35 mm



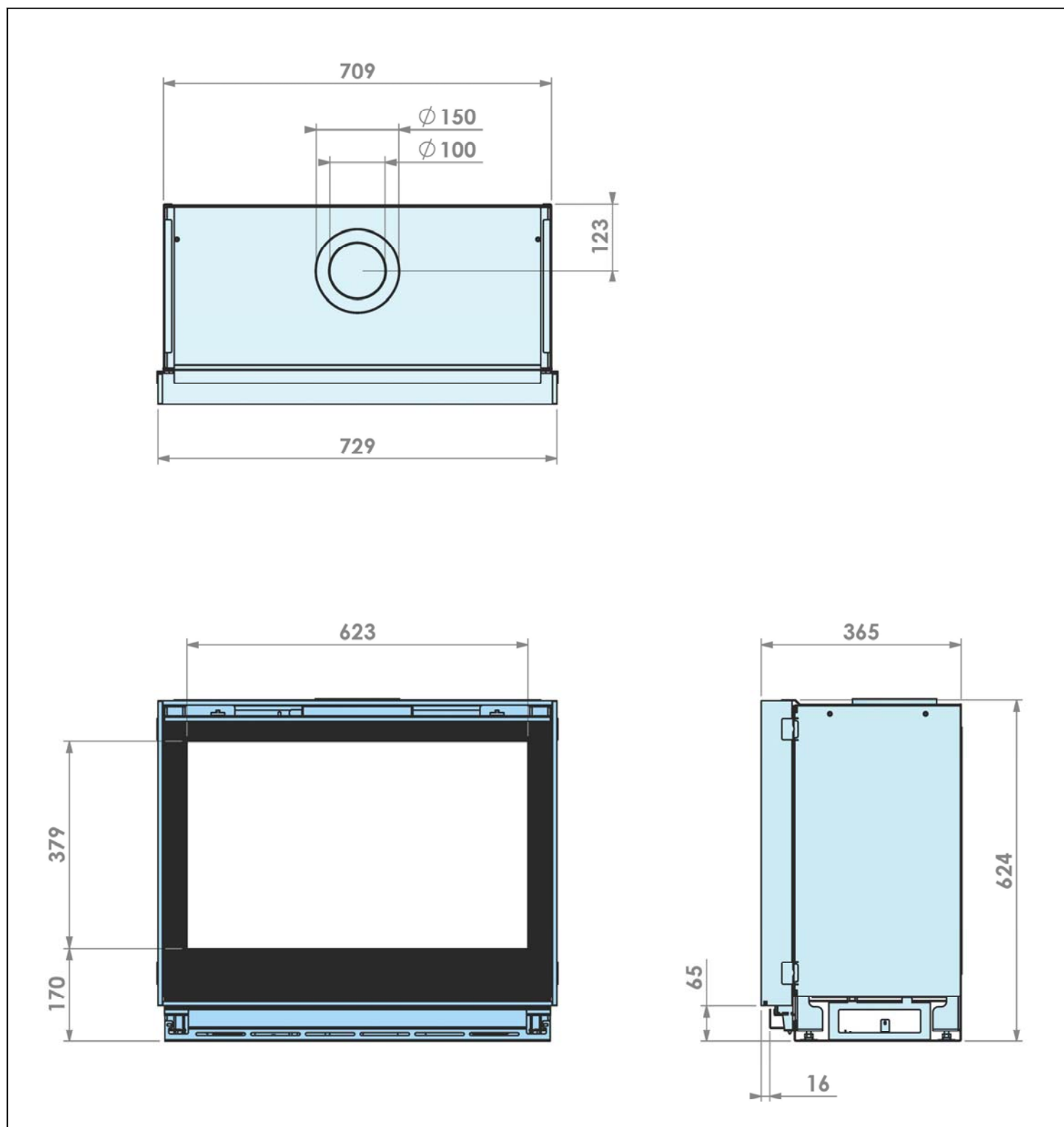
### 5.3 Dimensions Smart Bell 75/60 with a Classic frame 52 mm



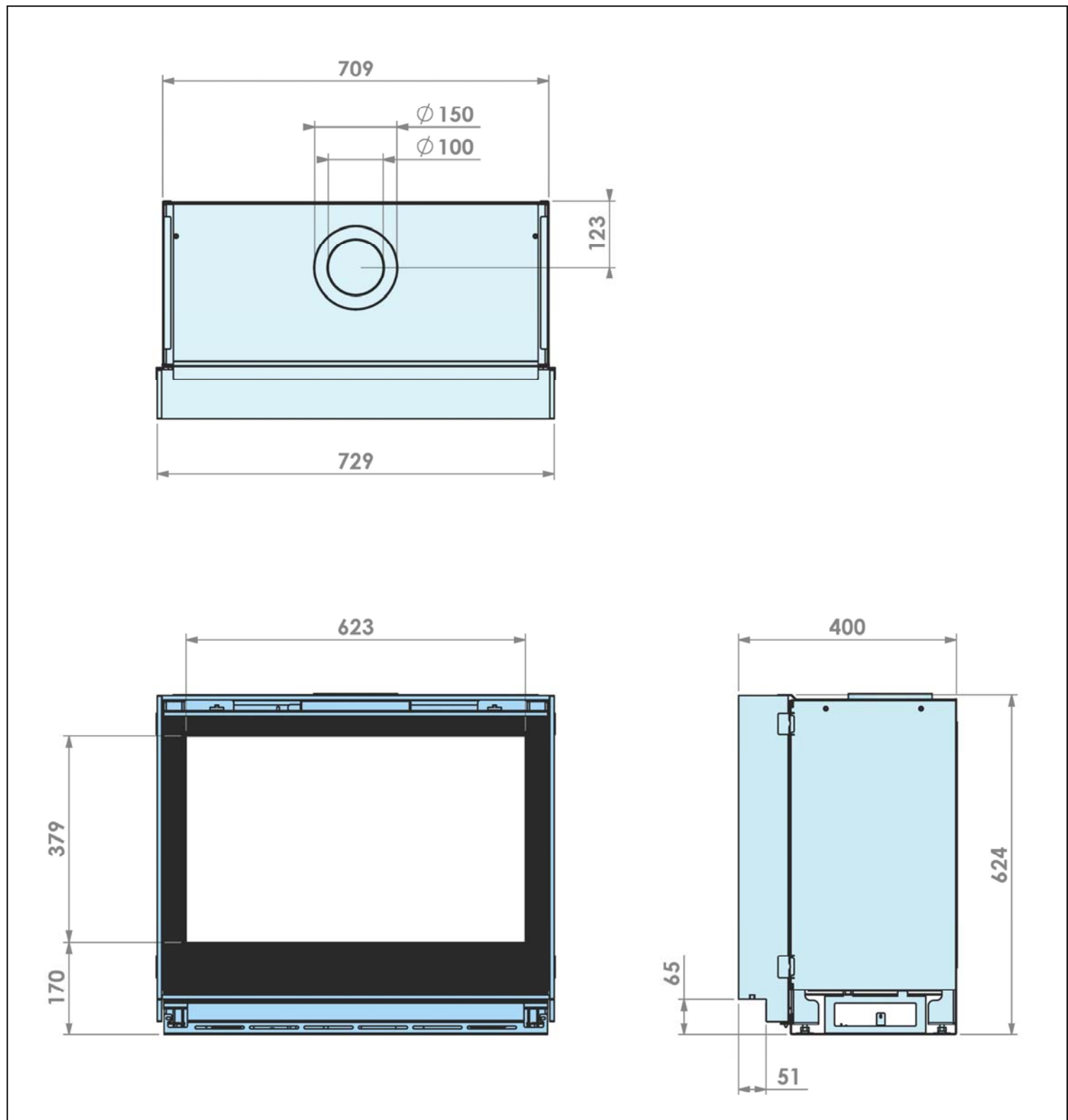
### 5.4 Dimensions Smart Bell 75/60 with a Classic frame 70 mm



**5.5 Dimensions Smart Bell 75/60 with an Insert frame 15 mm**

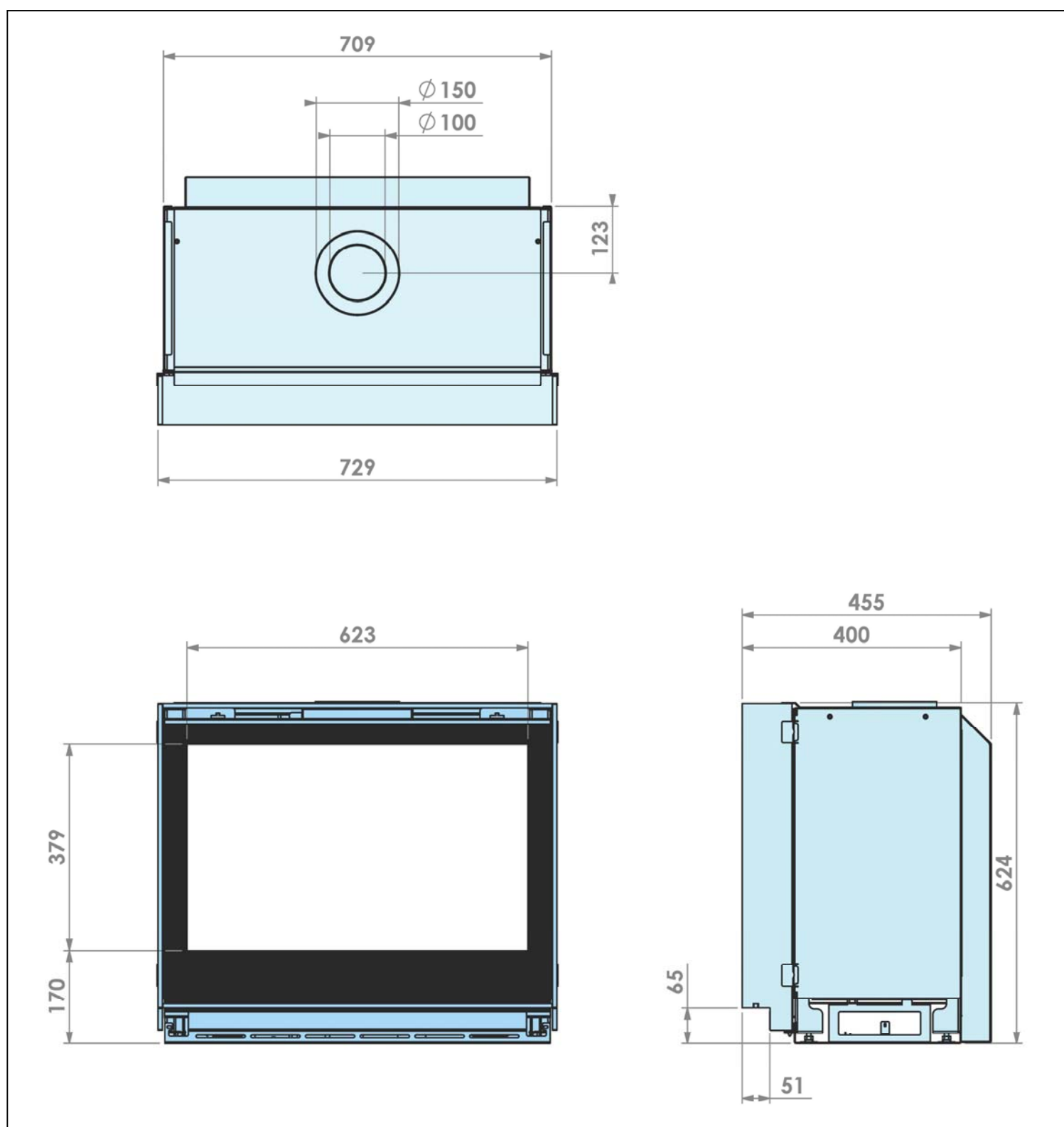


### 5.6 Dimensions Smart Bell 75/60 with an Insert frame 50 mm





**5.7 Dimensions Smart Bell 75/60 with an Insert frame 50 mm and Convection fan**



**5.8 Dimensions of the restriction plate**

Width of the delivered flue restriction plates in mm	
Concentric flue connection Ø100 - Ø150	
Roof-mounted outlet	
	30
	40
	50
	65

## 6 Available components for the concentric flue system



**Caution:**

Observe the installation instructions that are supplied with the components of the concentric flue system.

The gas fire, in combination with the concentric flue system [Ø100 mm - Ø150 mm] (rigid and/or flexible) for the brand types mentioned below, has been approved in accordance with the European CE-norm for gas appliances and may therefore be used only with these systems.

**Table 1: Approved brands**

Manufacturer	system
Belfires	Muelink & Grol system
Poujoulat	DUOGAS system
Ontop	Metaloterm US system
Jeremias/STB (STB = Schoorsteen Techniek Brummen NL)	H-Twin system
Jeremias	TWIN-GAS system

The permitted components for these systems are listed in this chapter. The guarantee on the appliance lapses if it is installed, fully or partially, with other components or a different flue system. The concentric flue [Ø100 mm - Ø150 mm] systems can be used with either a newly-built or existing chimney.

Make sure that the wall or roof termination kit that is used for the installation of the concentric flue system is also listed in the available parts list.

### 6.1 Appliance part list

Fig No.	Description
1	Gas fire; Concentric flue connection Ø100/Ø150 mm.
2	-
3	-
4	Restriction plate (The different sizes restriction plates are supplied with every appliance).
5	Chimney, min. Ø150 mm internal, totally gas tight.
6	Chimney or fireproof sleeving, min. Ø160 mm internal.
7	Ø100 mm internal flexible stainless steel gas vent chimney liner AISI 316TI.
8	Ø150 mm internal flexible stainless steel gas vent chimney liner AISI 316TI.
9	-

6.2 Bellfires - Muelink & Grol system Ø100 - Ø150







Fig. NO.	Bellfires Art./ ORDER NO.	DESCRIPTION		Color (*)		Application	
				rvs	antr.	rigid	flex
10	302289	Twin-wall balanced flue pipe. L= 500 mm.		•		•	
11	302290	Twin-wall balanced flue pipe. L= 1000 mm.		•		•	
12	302291	Telescopic twin-wall balanced flue pipe, L= min. 325 / max. 440 mm.		•		•	
13	302292	Adjustable length twin-wall balanced flue pipe, L= 500 mm.		•		•	
14	302297	Twin-wall balanced flue elbow 90°.		•		•	

Fig. NO.	Bellfires Art./ ORDER NO.	DESCRIPTION		Color (*)		Application	
				rvs	antr.	rigid	flex
15	302298	Twin-wall balanced flue elbow 45°.		•		•	
16	302295	Vertical (roof) termination kit, L= 1360 mm.		•	•	•	•
17	302212	Adjustable roof flashing. Roof pitch 20° - 45° (**), with lead flashing.		•		•	•
18	302213	Roof flashing for existing chimney or flat roof.		•		•	•
19	302296	Horizontal (wall) termination kit, L= 600 mm (adjustable), including a set of wall spacer plates.		•	•	•	•
20	302293	Stainless steel locking band Ø150 mm, quick-fastening.		•		•	•
21	302210	Silicone seal Ø150 mm.				•	•
23	302215	Wall strap.		•		•	•
24	302214	Set of ceiling finishing plates / Fire stops.		•		•	•

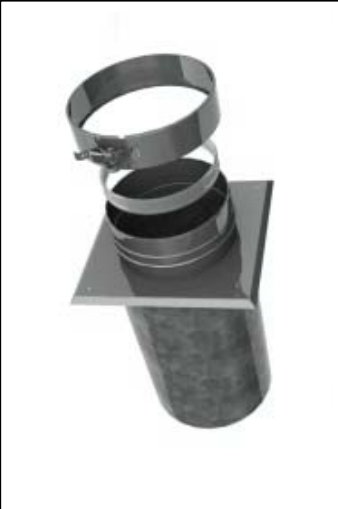
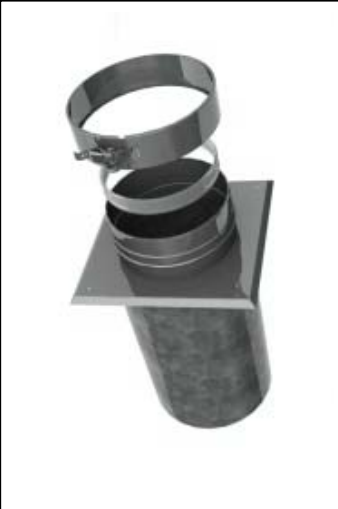
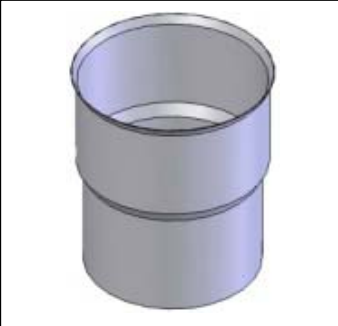
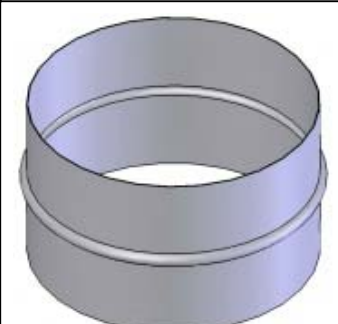




Fig. NO.	Bellfires Art./ ORDER NO.	DESCRIPTION		Color (*)		Application	
				rvs	antr.	rigid	flex
25	302189	Ceiling plate for transition Ø100 mm / Ø150 mm rigid - Ø100 mm (flex.).		•		•	•
26	302278	Stainless steel adapter piece (100) from fire to fl exible, Ø100 mm external (rigid) x Ø107 mm internal (flex.). [appliance - Ø100 mm flex.] and [Ø100 mm rigid - Ø100 mm flex.].		•			•
27	302279	Stainless steel adapter piece (150) fire to fl exible, Ø148 mm external (rigid) x Ø148 mm internal (flex.) [appliance - Ø150 mm flex.].		•			•
28	302217	Stainless steel locking band Ø150 mm. For adapter 150 [appliance - Ø150 mm (flex.)], Screw-fastening.		•		•	•
29	303776	Stainless steel screws Ø3.5 mm x 9.5 mm. For securing the flexible concentric flue. (Minimum 3 screws per connection).		•			•
30	304041	Hose clamp Ø100 mm. (Minimum 2 per connection).		•			•
31	304042	Hose clamp Ø150 mm. (Minimum 2 per connection)		•			•

Fig. NO.	Bellfires Art./ ORDER NO.	DESCRIPTION		Color (*)		Application	
				rvs	antr.	rigid	flex
32	302307	Vertical (roof) termination kit, L = 610 mm. Suitable for a flexible flue system.		•	•	•	•
33	302301	Concentric T-piece with gauging orifice.		•		•	
34	302302	Concentric pipe with gauging orifice, L = 165 mm.		•		•	
35	302303	90° concentric bend with inspection panel.		•		•	
36	321948	Universal wall / floor support Ø150 mm		•		•	

(\*)Color

- rvs : Stainless steel self-color, polished
- antr. : Anthacite color lacquer, matt

(\*\*) Adjustable roof flashing for a slope > 45° can be supplied on request.

When installing a balanced-flue “closed” gas fire in an existing chimney, ensure stainless steel flexible liners (Ø100 mm or Ø130 mm) conforming with BS 316 are used to conduct the spent gases.

**6.3 Poujoulat - DUOGAS system Ø100 - Ø150**

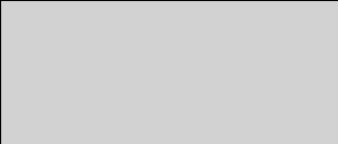








Fig. NO.	Poujoulat Art./ ORDER NO.	DESCRIPTION		Color (*)		Application	
				rvs	antr.	rigid	flex
	37100403	Twin-wall balanced flue pipe, L= 250 mm.					
10	37100404	Twin-wall balanced flue pipe, L= 450 mm.		•		•	
11	37100405	Twin-wall balanced flue pipe, L= 950 mm.		•		•	
12	37100429	Telescopic twin-wall balanced flue pipe, L= min. 390 / max. 640 mm.		•		•	
14	37100441	Twin-wall balanced flue elbow 90°.		•		•	
15	37100421	Twin-wall balanced flue elbow 45°.		•		•	
	37100411	Twin-wall balanced flue elbow 30°.		•		•	
	37100401	Twin-wall balanced flue elbow 15°.		•		•	



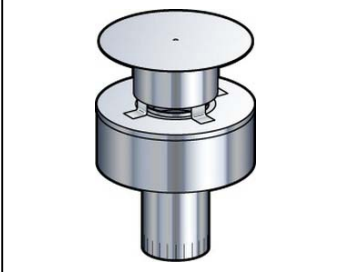
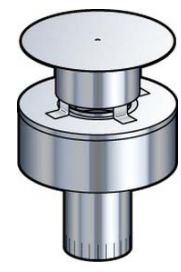
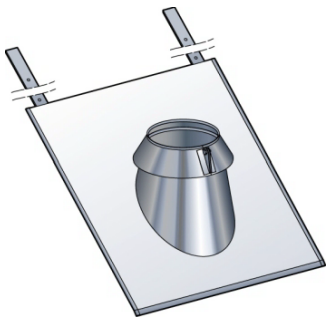
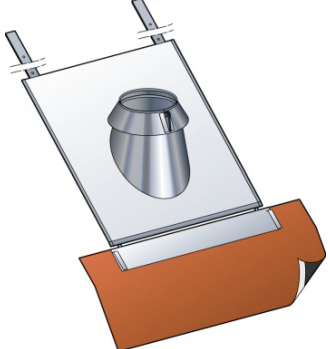

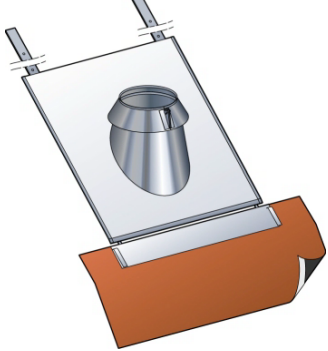

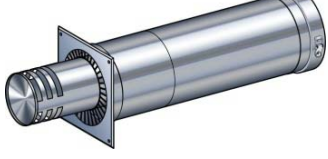

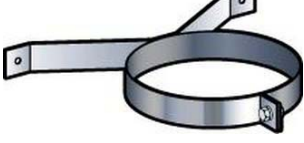
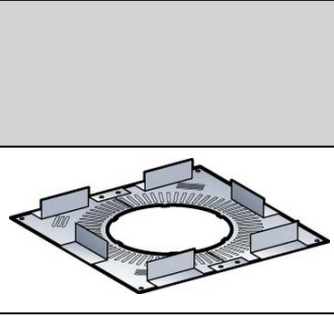
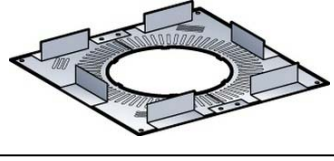
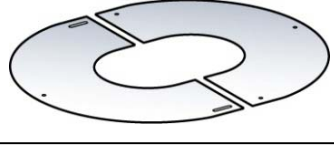
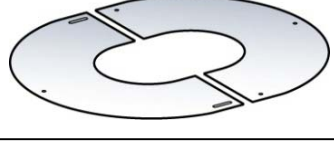
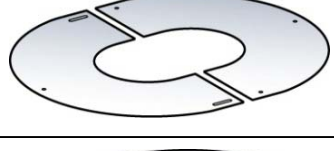


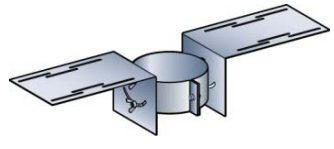
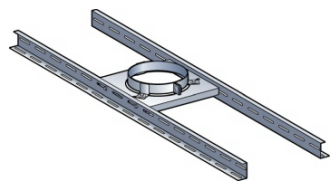


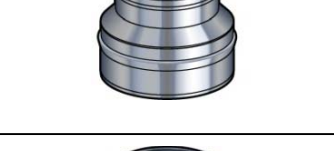
Fig. NO.	Poujoulat Art./ ORDER NO.	DESCRIPTION		Color (*)		Application	
				rvs	antr.	rigid	flex
16	37100654	Vertical (roof) termination kit, L= 140 mm .		•		•	
17	45150171	Roof flashing, suitable for a brick roof, with a roof pitch of 15°- 30°.		•		•	
17	45150170	Roof flashing, suitable for a tiled roof, with a roof pitch of 15°- 30°.		•		•	
17	45150172	Roof flashing, suitable for a brick roof, with a roof pitch of 30°- 45°.		•		•	
17	45150173	Roof flashing, suitable for a tiled roof, with a roof pitch of 30°- 45°.		•		•	
18	45150169	Roof flashing for existing chimney or flat roof.		•		•	
19	37100610	Horizontal (wall) termination kit, L= min. 365 mm / max. 585 mm.		•		•	
20	45150076	Stainless steel locking band Ø150 mm, quick-fastening.		•		•	
23	45150072	Wall strap, Ø150 mm.		•		•	

Fig. NO.	Poujolat Art./ ORDER NO.	DESCRIPTION		Color (*)		Application	
				rvs	antr.	rigid	flex
24	37100442	Ceiling/wall plate with spacers and ventilation grooves.		•		•	
24	37100425	Set of ceiling finishing plates / Fire stops, suitable for a roof pitch of 0°- 10°.		•		•	
24	37100426	Set of ceiling finishing plates / Fire stops, suitable for a roof pitch of 10°- 30°.		•		•	
24	37100427	Set of ceiling finishing plates / Fire stops, suitable for a roof pitch of 30°- 40°.		•		•	
24	37100428	Set of ceiling finishing plates / Fire stops, suitable for a roof pitch of 40°- 50°.		•		•	
34	37100407	Concentric pipe with inspection opening, L= 250 mm.		•		•	
36	45150165	Roof support, (universal) Ø150 mm.		•		•	
36	45150081	Floor support, (universal) Ø150 mm.		•		•	
37	37100611	Adapter: Bellfires Ø100-150 mm → Poujolat DUOGAS Ø100-150 mm (Appliance 100/150 → Poujolat DUOGAS 100/150)		•		•	
100	37100614	Adapter: Bellfires Ø130-200 mm → Poujolat DUOGAS Ø100-150 mm (Appliance 130/200 → Poujolat DUOGAS 100/150)		•		•	
101	37100613	Concentric reduction of Poujolat DUOGAS Ø130-200 mm → Poujolat DUOGAS Ø100-150 mm		•		•	

6.4 Ontop - Metaloterm US system Ø100 - Ø150

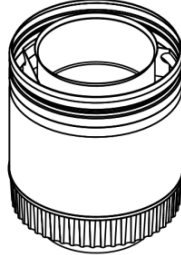
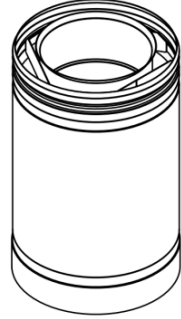
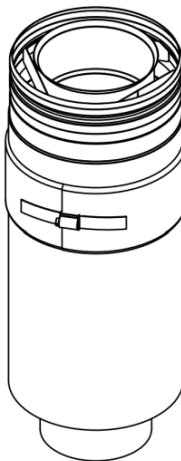
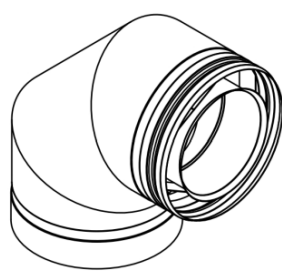
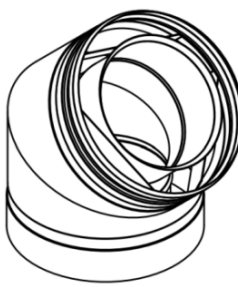
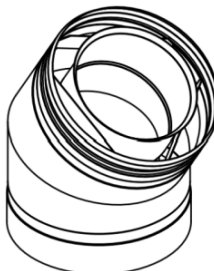
Fig. NO.	Ontop Art./ ORDER NO.	DESCRIPTION		Color (*)		Application	
				rvs	antr.	rigid	flex
	USA 10	Adapter for Belfires appliances with Ø100-Ø150 mm concentric connection.		•		•	
	US 25 10	Twin-wall balanced flue pipe, L = 250 mm.		•		•	
10	US 50 10	Twin-wall balanced flue pipe. L= 500 mm.		•		•	
11	US 100 10	Twin-wall balanced flue pipe. L= 1000 mm.		•		•	
12	USPP 10	Telescopic twin-wall balanced flue pipe, L= min. 60 / max. 250 mm.		•		•	
14	USB 90 10	Twin-wall balanced flue elbow 90°.		•		•	
15	USB 45 10	Twin-wall balanced flue elbow 45°.		•		•	
15	USB 30 10	Twin-wall balanced flue elbow 30°.		•		•	

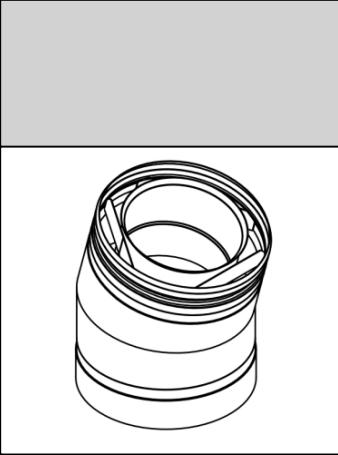
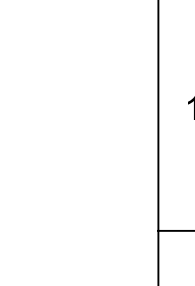
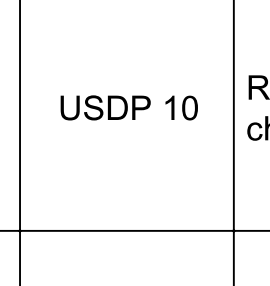
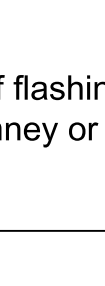
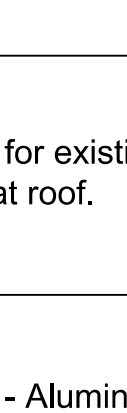
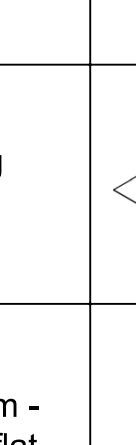

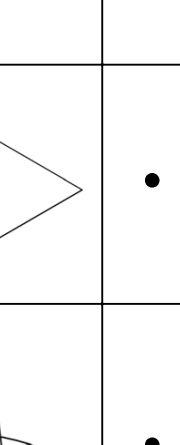
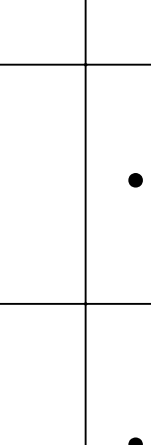

Fig. NO.	Ontop Art./ ORDER NO.	DESCRIPTION		Color (*)		Application	
				rvs	antr.	rigid	flex
15	USB 15 10	Twin-wall balanced flue elbow 15°.		•		•	
16	USDVC2 10	Vertical (roof) termination kit, L= 375 mm.		•		•	
16	USSR 10	Storm collar Ø150 mm.		•		•	
17	USLS 10	Adjustable roof flashing. Roof pitch 20° - 45°, with lead flashing.		•		•	
17	USDH 10	Roof flashing plate for roof pitch 5° - 30°.		•		•	
18	USDP 10	Roof flashing for existing chimney or flat roof.		•		•	
18	USDPAL 10	Roof flashing - Aluminium - For existing chimney or flat roof.		•		•	
19	USDHC5 10	Horizontal (wall) termination kit, L= 475 mm (adjustable).		•		•	
20	USKB 10	Locking band, quick-fastening.		•		•	

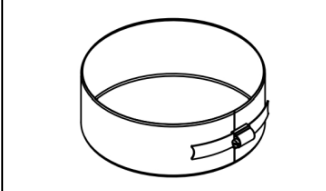
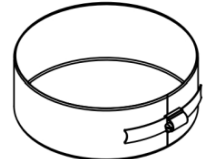
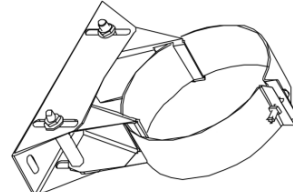
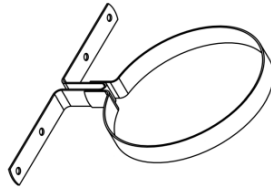
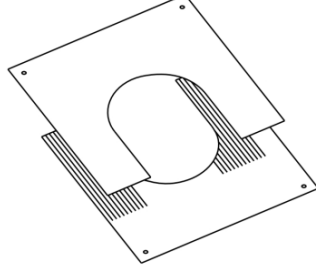
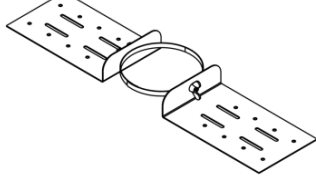
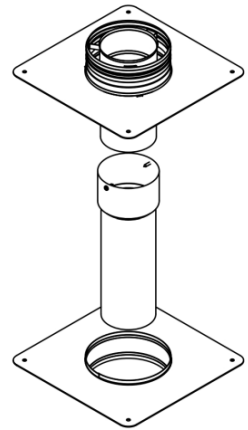
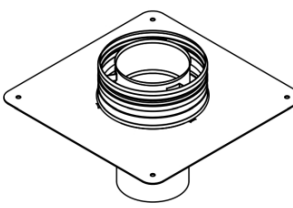
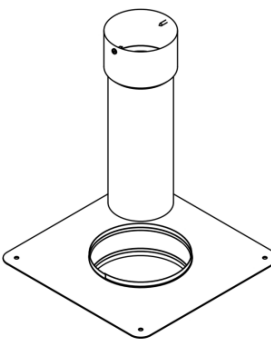
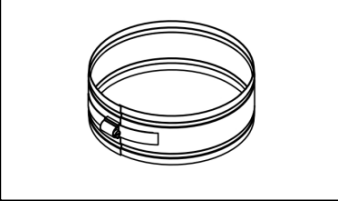
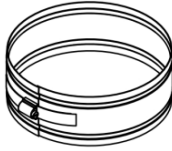
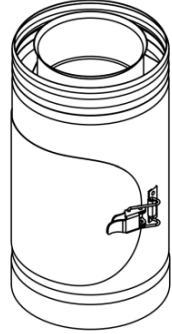

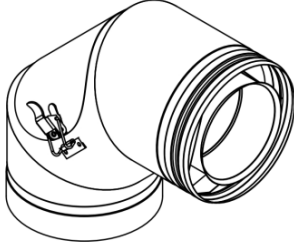
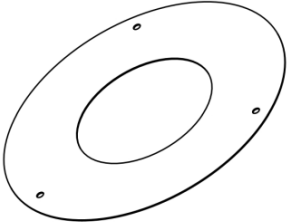
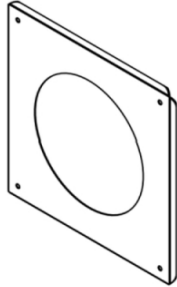
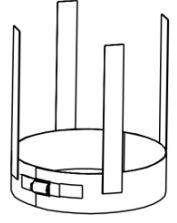

Fig. NO.	Ontop Art./ ORDER NO.	DESCRIPTION		Color (*)		Application	
				rvs	antr.	rigid	flex
21	USAB 10	Cover band, screw-fastening.		•		•	
23	USMB 10	Wall strap, adjustable.		•		•	
23	USEB 10	Fitting bracket.		•		•	
24	USCP 10	Set of ceiling finishing plates / Fire stops / Centring plates.		•		•	
24	USDQ 10	Roof support.		•		•	
25	USSAN 10	Renovation set.		•		•	
25	USSAN1 10	Top of renovation set.		•		•	
25	USSAN2 10	Bottom renovation set.		•		•	

Fig. NO.	Ontop Art./ ORDER NO.	DESCRIPTION		Color (*)		Application	
				rvs	antr.	rigid	flex
28	USKBS 10	Locking band, screw-fastening.		•		•	
	USI 10	Concentric pipe with inspection panel, L= 250 mm.		•		•	
34	USEM 10	Concentric pipe with gauging orifice, L= 150 mm.		•		•	
35	USBI 10	90° concentric bend with inspection panel.		•		•	
	USR 10	Rosette smooth Ø150 mm.		•		•	
	USMPG 10	Wall plate large Ø150 mm, square 300 mm.		•		•	
	USAH 10	Spacer bracket.		•		•	
	USVG 10 13	Concentric reduction of Ø100-Ø150 mm → Ø130-Ø200 mm.		•		•	



## 6.5 Jeremias/STB - H-Twin system Ø100 - Ø150






Fig. NO.	Jeremias Art./ ORDER NO.	DESCRIPTION		Color (*)		Application	
				rvs	antr.	rigid	flex
11	ATWINL 13 100-150	Twin-wall balanced flue pipe. L= 1000 mm.		•		•	
10	ATWINL 14 100-150	Twin-wall balanced flue pipe. L= 500 mm.		•		•	
10	ATWINL 15 100-150	Twin-wall balanced flue pipe. L= 250 mm.		•		•	
12	H-TWIN 742 100-150	Telescopic twin-wall balanced flue pipe, L= min. 1100 / max. 1400 mm.					
12	H-TWIN 467 100-150	Telescopic twin-wall balanced flue pipe, L= min. 1100 / max. 1900 mm.		•		•	
12	ATWIN 197 100-150	Telescopic twin-wall balanced flue pipe, L= min. 600 / max. 900 mm.					
15	ATWIN 16 100-150	Twin-wall balanced flue elbow 15°.		•		•	



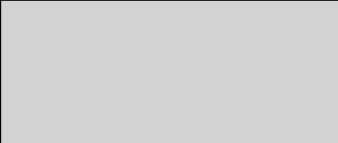
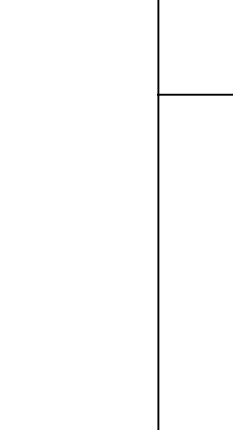
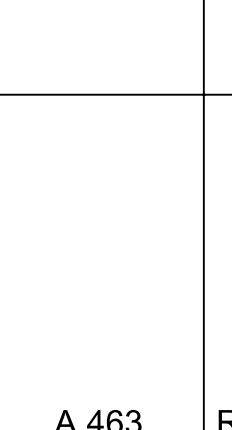

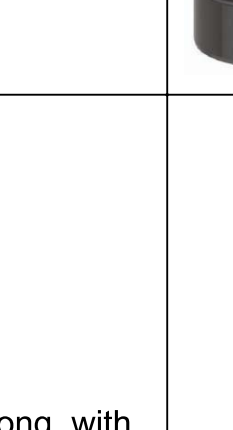
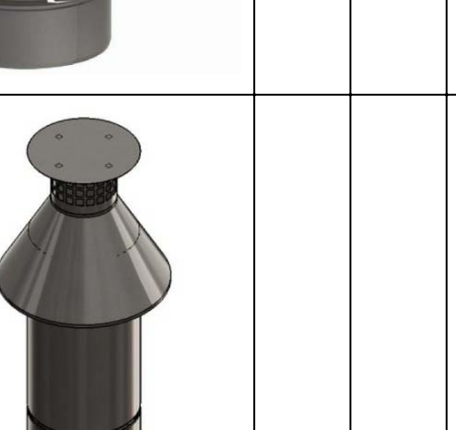
Fig. NO.	Jeremias Art./ ORDER NO.	DESCRIPTION		Color (*)		Application	
				rvs	antr.	rigid	flex
15	ATWIN 17 100-150	Twin-wall balanced flue elbow 30°.		•		•	
15	ATWIN 18 100-150	Twin-wall balanced flue elbow 45°.		•		•	
14	ATWIN 60 100-150	Twin-wall balanced flue elbow 90°.		•		•	
14	ATWIN 60F 100-150	Twin-wall balanced flue elbow 90° - Short. Especially for connection to a wall termination.		•		•	
16	A 463 100-150	Roof termination - long, with pipe, L = 1080 mm, Vertical.		•		•	




Fig. NO.	Jeremias Art./ ORDER NO.	DESCRIPTION		Color (*)		Application	
				rvs	antr.	rigid	flex
16	ATWIN 92 100-150	Roof termination - short with pipe, L = 300 mm, Vertical.		•	•	•	
32	ATWIN 92pe 100-150	Roof termination, with pipe, L = 495 mm, Vertical, with roof flashing for existing chimney or flat roof.		•	•	•	
17	ATWIN 45DD 100-150	Roof flashing for roof pitch 30°, with lead flashing and storm collar.		•	•	•	
17	ATWIN 60DD 100-150	Roof flashing for roof pitch 45°, with lead flashing and storm collar.		•		•	
	ATWIN 307 100-150	Storm collar.		•		•	
24	ADBL-DW 100-150	Set of ceiling finishing plates / Fire stops.		•		•	
20	ATWIN 45 100-150	Locking band, Screw-fastening (Standard on all components).		•		•	
23	ATWIN 22 100-150	Wall strap, adjustable.		•		•	
23	ATWIN 23 100-150	Wall strap, distance adjustable 60-250 mm.		•		•	

Fig. NO.	Jeremias Art./ ORDER NO.	DESCRIPTION		Color (*)		Application	
				rvs	antr.	rigid	flex
19	A681 100-150	Horizontal (wall) termination kit, L= 495 mm (horizontally adjustable), including one set of wall spacer plates.		•		•	
33	H-TWIN 752 100-150	Concentric T-piece with gauging orifice. Inspection panel with cover cap and condensation-opening.		•		•	
	ATWIN 465 100-150	Adapter: H-TWIN Ø100-150 → Flex Stainless steel ; Ø100 mm Incl. Ceiling plate 300x300 mm.		•		•	
	ATWIN 466 100-150	Adapter: Flex Stainless steel; Ø100 mm → H-TWIN Ø100-150 Incl. Chimney(ceiling)plate 300x300 mm.		•		•	
36	ASDH2 100-150	Universal wall / floor support Ø150 mm.		•		•	
100	A464 130	Concentric reduction of H-TWIN Ø130 / Ø200 mm → H-TWIN Ø100 / Ø150 mm.		•		•	

6.6 Jeremias - TWIN-GAS system Ø100 - Ø150






Fig. NO.	Jeremias Art./ ORDER NO.	DESCRIPTION		Color (*)		Application	
				rvs	antr.	rigid	flex
	TWG1634 100-150	Belfires Appliance connection / Adapter Belfires Ø100/150 mm → Jeremias TWIN-GAS Ø100/150 mm L = 160 mm Including locking band (2x).		•		•	
11	TWG13 100-150	Twin-wall balanced flue pipe, L = 1000 mm Including locking band.		•		•	
10	TWG14 100-150	Twin-wall balanced flue pipe, L = 500 mm Including locking band.		•		•	
10	TWG15 100-150	Twin-wall balanced flue pipe, L = 250 mm Including locking band.		•		•	
	TWG1801 100-150	Twin-wall balanced flue pipe, L = 1000 mm with 4 spacer brackets on the outside Including locking band.		•		•	









Fig. NO.	Jeremias Art./ ORDER NO.	DESCRIPTION		Color (*)		Application	
				rvs	antr.	rigid	flex
12	TWG50 100-150	Telescopic twin-wall balanced flue pipe, L= min. 330 / max. 420 mm Including locking band.		•		•	
15	TWG16 100-150	Twin-wall balanced flue elbow 15°. Including locking band.		•		•	
15	TWG17 100-150	Twin-wall balanced flue elbow 30°. Including locking band.		•		•	
15	TWG18 100-150	Twin-wall balanced flue elbow 45°. Including locking band.		•		•	
14	TWG60 100-150	Twin-wall balanced flue elbow 90°. Including locking band.		•		•	
14	TWG1786 100-150	Twin-wall balanced flue elbow 90° - with support leg Including locking band and sealing cap under.		•		•	
14	TWG1676 100-150	Twin-wall balanced flue elbow 90° - short - eccentric. Especially for connection to a wall termination TWG1619 Including locking band.		•		•	








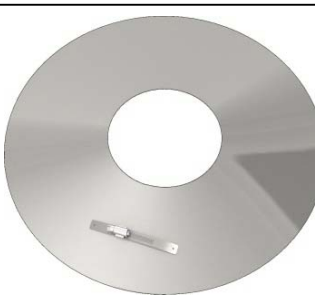
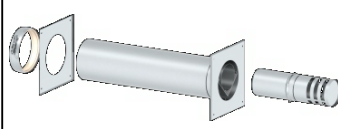
Fig. NO.	Jeremias Art./ ORDER NO.	DESCRIPTION		Color (*)		Application	
				rvs	antr.	rigid	flex
16	TWG272 100-150	Roof termination (vertical) L= 615 mm. Including locking band.		•		•	
17	TW53 150	Roof flashing with a roof pitch of 5° - 15° With flex alu-flashing and storm collar.		•		•	
17	TW59 150	Roof flashing with a roof pitch of 16° - 25° With flex alu-flashing and storm collar.		•		•	
17	TW38 150	Roof flashing with a roof pitch of 26° - 35° With flex alu-flashing and storm collar.		•		•	
17	TW54 150	Roof flashing with a roof pitch of 36° - 45° With flex alu-flashing and storm collar.		•		•	
18	TW52 150	Roof flashing for existing chimney or flat roof With storm collar.		•		•	
	KL72 150	Storm collar (spare part).		•		•	
19	TWG1619 100-150	Wall termination kit, L= 600 mm (horizontal) Adjustable. Incl. locking band and one set of wall spacer plates.		•		•	










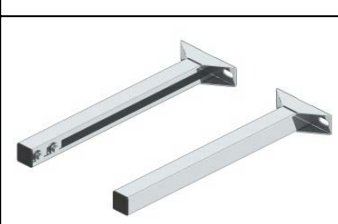
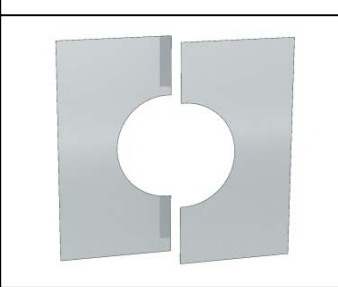
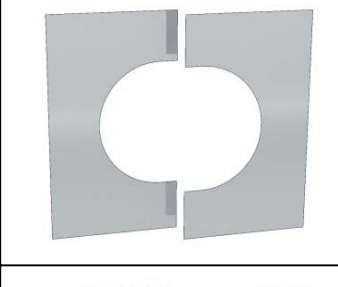
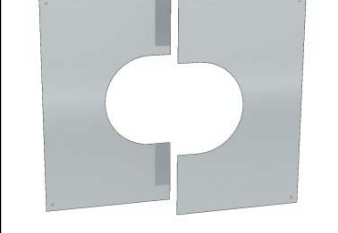
Fig. NO.	Jeremias Art./ ORDER NO.	DESCRIPTION		Color (*)		Application	
				rvs	antr.	rigid	flex
20	TW45 150	Locking band, screw-fastening (spare part).		•		•	
21	ALBI26 150	Silicone sealing ring for outer pipe (spare part).				•	
23	ZUWA704 150	Wall strap. Distance to the wall: WA= 50 mm.		•		•	
	ZU-WA891130	Extension pieces for the wall strap ZUWA704 L= 130 mm.		•		•	
	ZU-WA891200	Extension pieces for the wall strap ZUWA704 L= 200 mm.		•		•	
	ZU-WA891250	Extension pieces for the wall strap ZUWA704 L= 250 mm.		•		•	
	ZUWA706	Extension pieces for the wall strap ZUWA704 L= 400 mm, WA = 50 - 360 mm.		•		•	
24	ZUDA074 150	Set of ceiling finishing plates / Fire stops for a flat roof : 0°.		•		•	
24	ZUDA99V 150	Set of ceiling finishing plates / Fire stops for a pitched roof : 0° - 30°.		•		•	
24	ZUDA98V 150	Set of ceiling finishing plates / Fire stops for a pitched roof : 31° - 45°.		•		•	

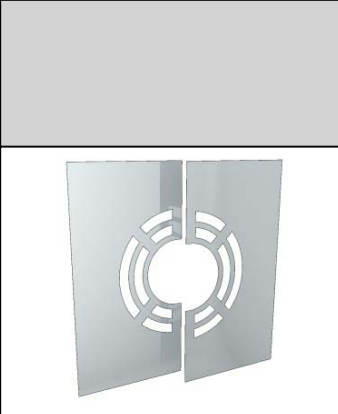

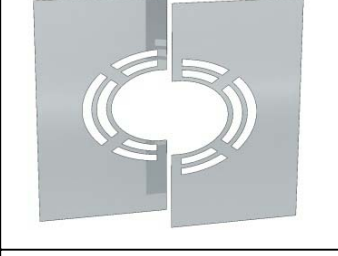








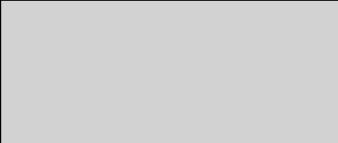






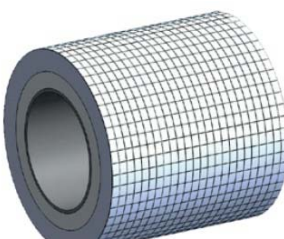
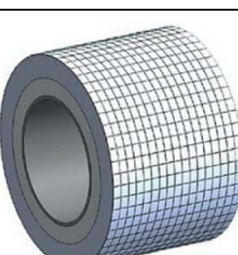
Fig. NO.	Jeremias Art./ ORDER NO.	DESCRIPTION		Color (*)		Application	
				rvs	antr.	rigid	flex
24	ZU-DA99VHL 150	Set of ceiling finishing plates / Fire stops with ventilation openings for a pitched roof : 0° - 30°.		•		•	
24	ZU-DA98VHL 150	Set of ceiling finishing plates / Fire stops with ventilation openings for a pitched roof : 31° - 45°.		•		•	
25	FD08 100	Adapter: TWIN-GAS to FLEX. (only for the inner pipe Ø100 mm).		•		•	
25	TWG1276D 100-150	Chimney-/flat roof-/ceiling - plate with adapter: FLEX to TWIN-GAS.		•		•	
25	ZUWA1618 100	Adapter: TWIN-GAS to 'Schaft' (DE).		•		•	
25	TWG1732 100-150	Chimney-/flat roof-/ceiling - plate with adapter: Ø100 rigid/flex to TWIN- GAS .		•		•	
33	TWG317 100-150	Concentric T-piece 90°. Including locking band.		•		•	
34	TWG51 100-150	Concentric pipe with gauging orifice L= 200 mm. Including locking band.		•		•	
35	TWG10 100-150	Concentric pipe, L= 300 mm with cleaning opening/inspection panel. Including locking band.		•		•	
35	TWG19 100-150	Concentric elbow 90° with cleaning opening/inspection panel. Including locking band.		•		•	



Fig. NO.	Jeremias Art./ ORDER NO.	DESCRIPTION		Color (*)		Application	
				rvs	antr.	rigid	flex
36	TWG05 100-150	Base plate/Cover-under with 2x 1/2" gauging orifice, sealing cap and condensate drain at the bottom.		•		•	
36	TWG07 100-150	Base plate / floor support.		•		•	
	DW391	Wall support with transverse support Type I: 350 mm - Distance to wall: WA= max. 50 mm.		•		•	
	DW392	Wall support with transverse support Type II: 500 mm - Distance to wall: WA= 50 - 150 mm.		•		•	
	DW393	Wall support with transverse support Type III: 750 mm - Distance to wall: WA= 150 - 250 mm.		•		•	
	DW407	Wall support with transverse support Type IV: 1030 mm - Distance to wall: WA= 250 - 360 mm.		•		•	
(17-24)	LUX-ECO 150	Insulation roof flashing, L= Max. 500 mm (adjustable). Wall thickness LUX-ECO Insulation: min. 25 mm.				•	
(19)	LUX-ECO 150	Insulation wall flashing, L= Max. 360 mm (adjustable). Wall thickness LUX-ECO Insulation: min. 25 mm.				•	





# bellfires.

Your Bellfires dealer